

## **Section 8: Data Plots**

C012DM09150Y0000.0UT

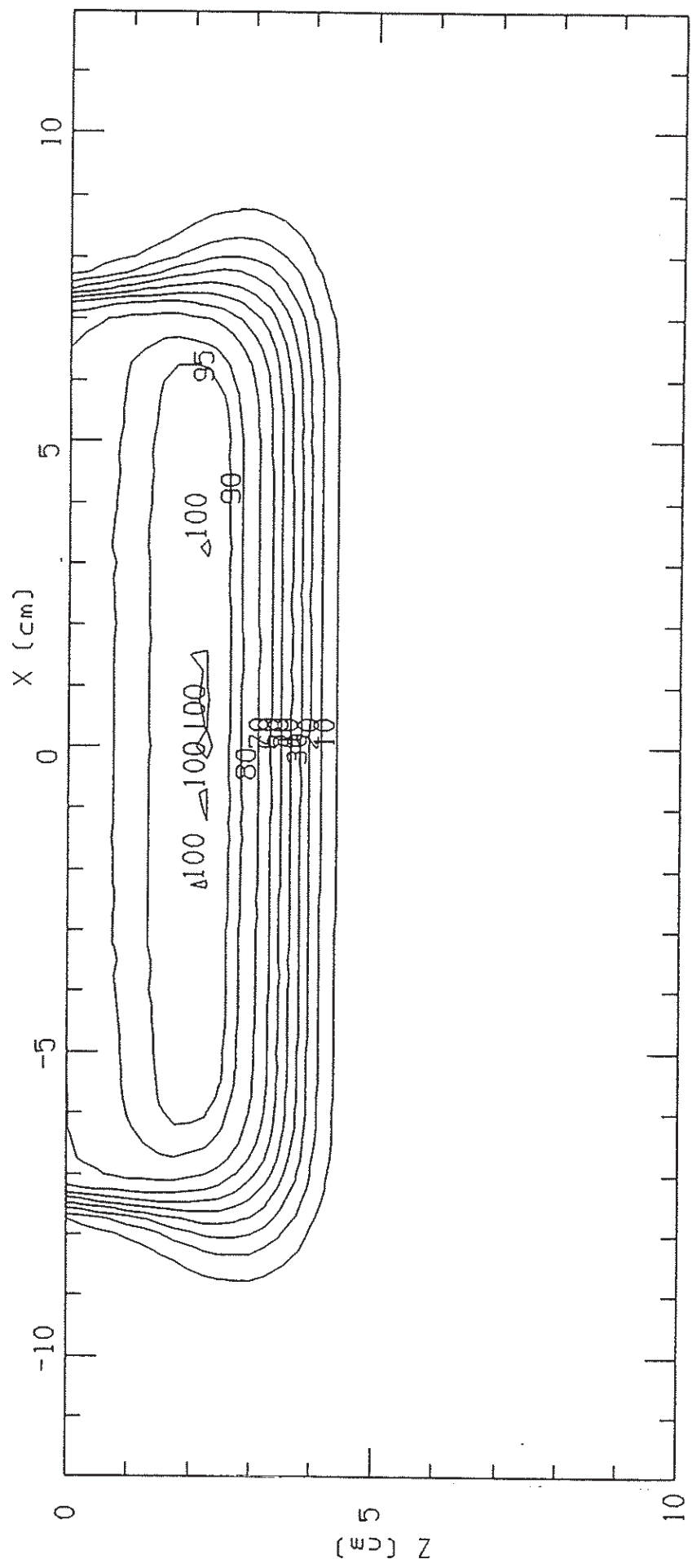

C012DM09150Y0055.OUT

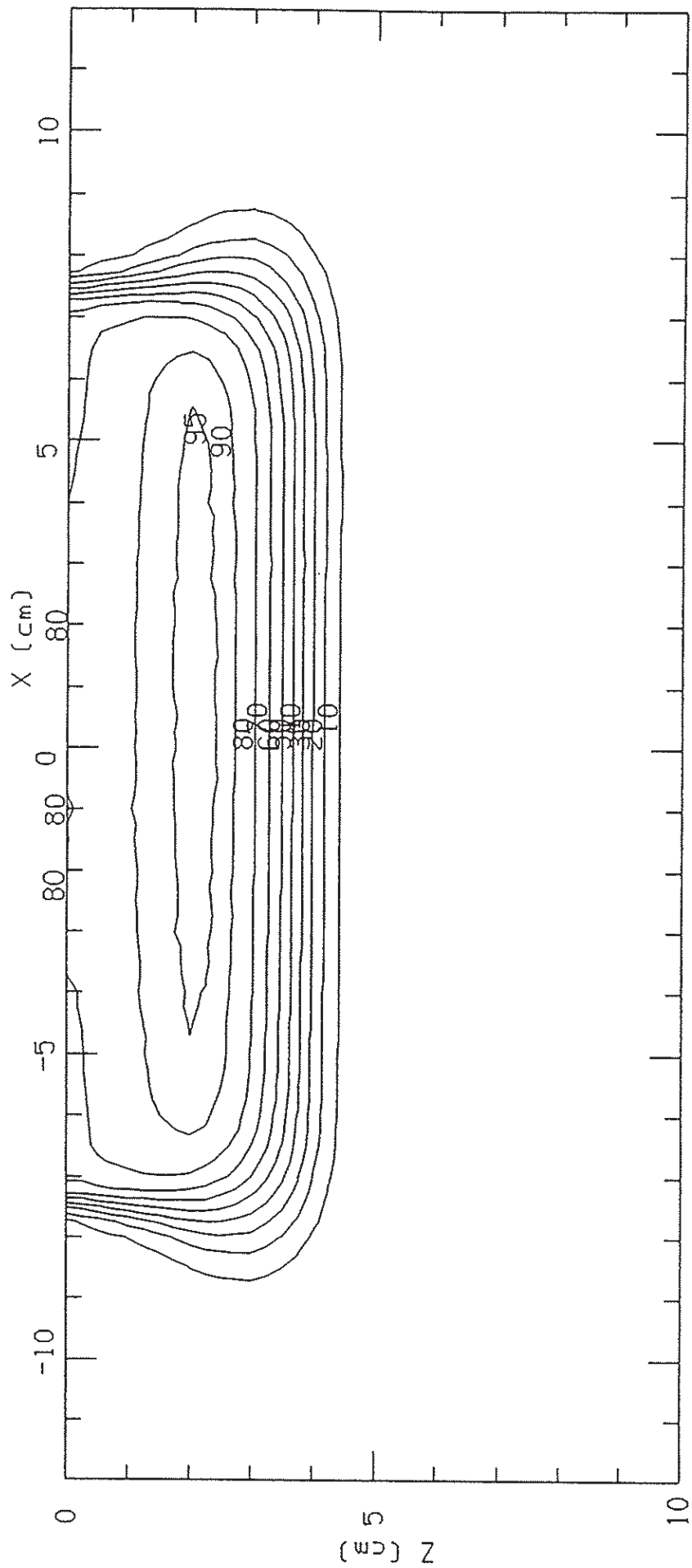

\* 8863

C022DM09060Y0000.0UT

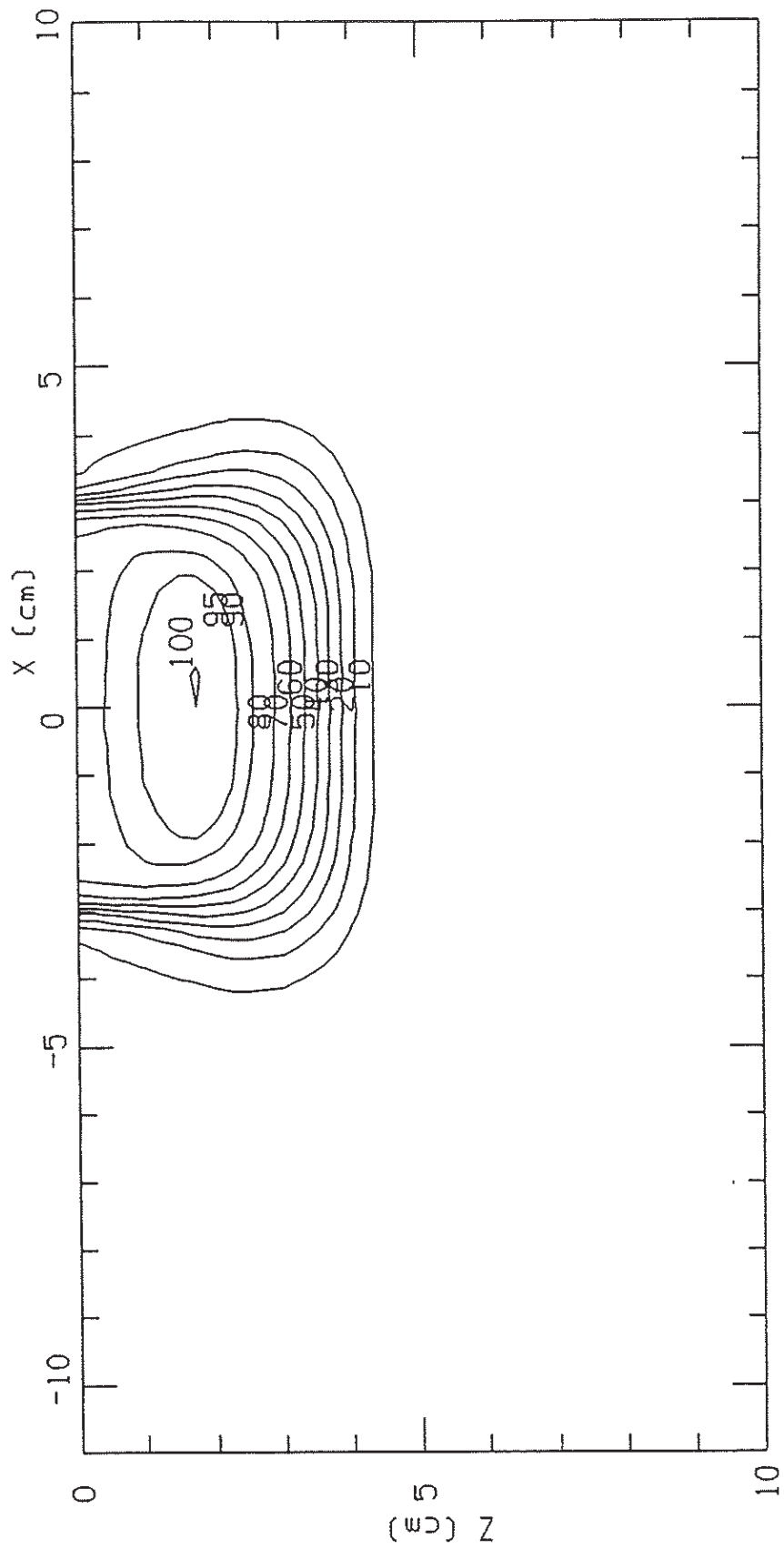

C032DM20150Y0000.0UT

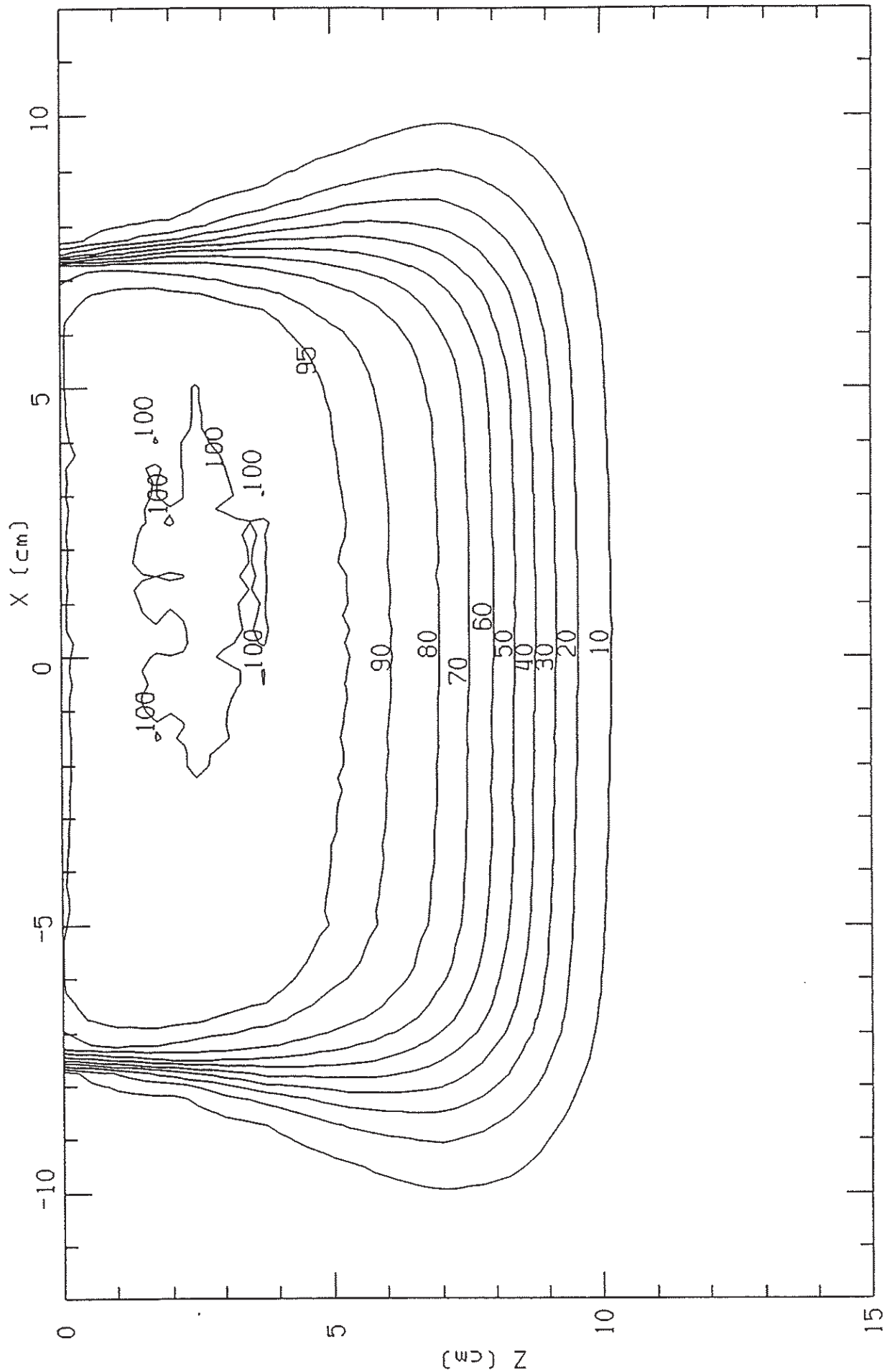

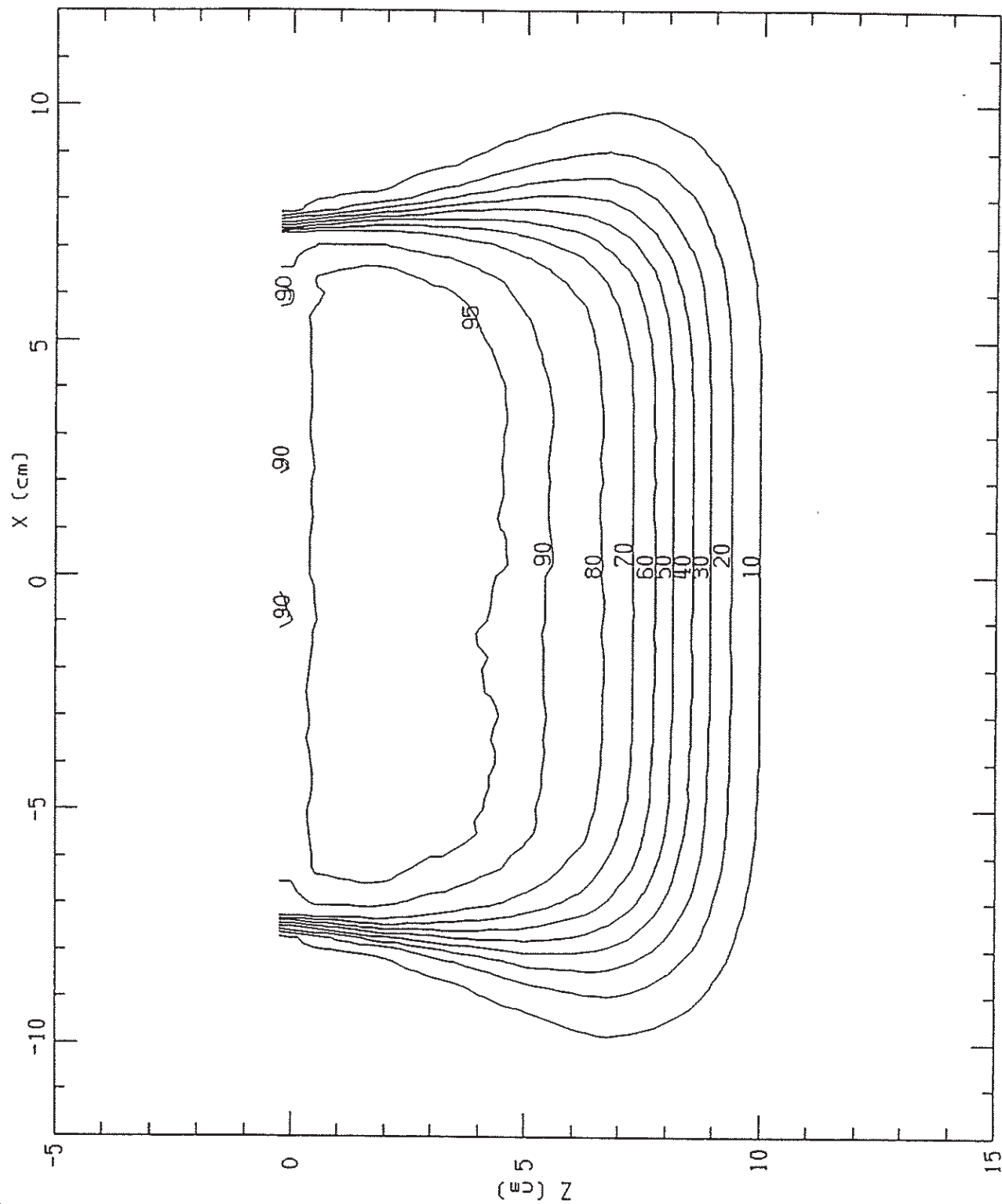

C042DM20060Y0000.OUT

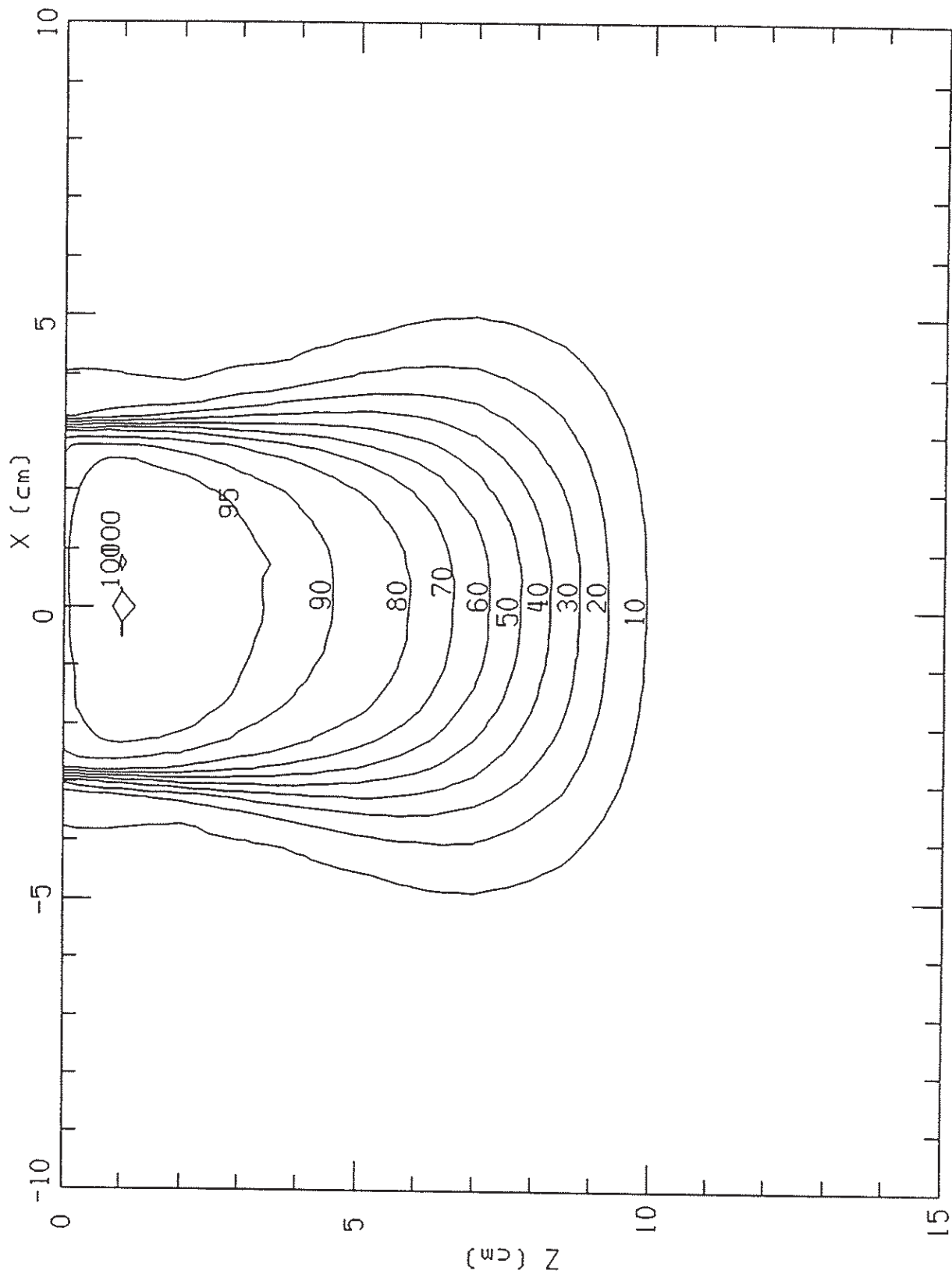

\* 88G3

C052DM09150Y0000\_MOD.OUT

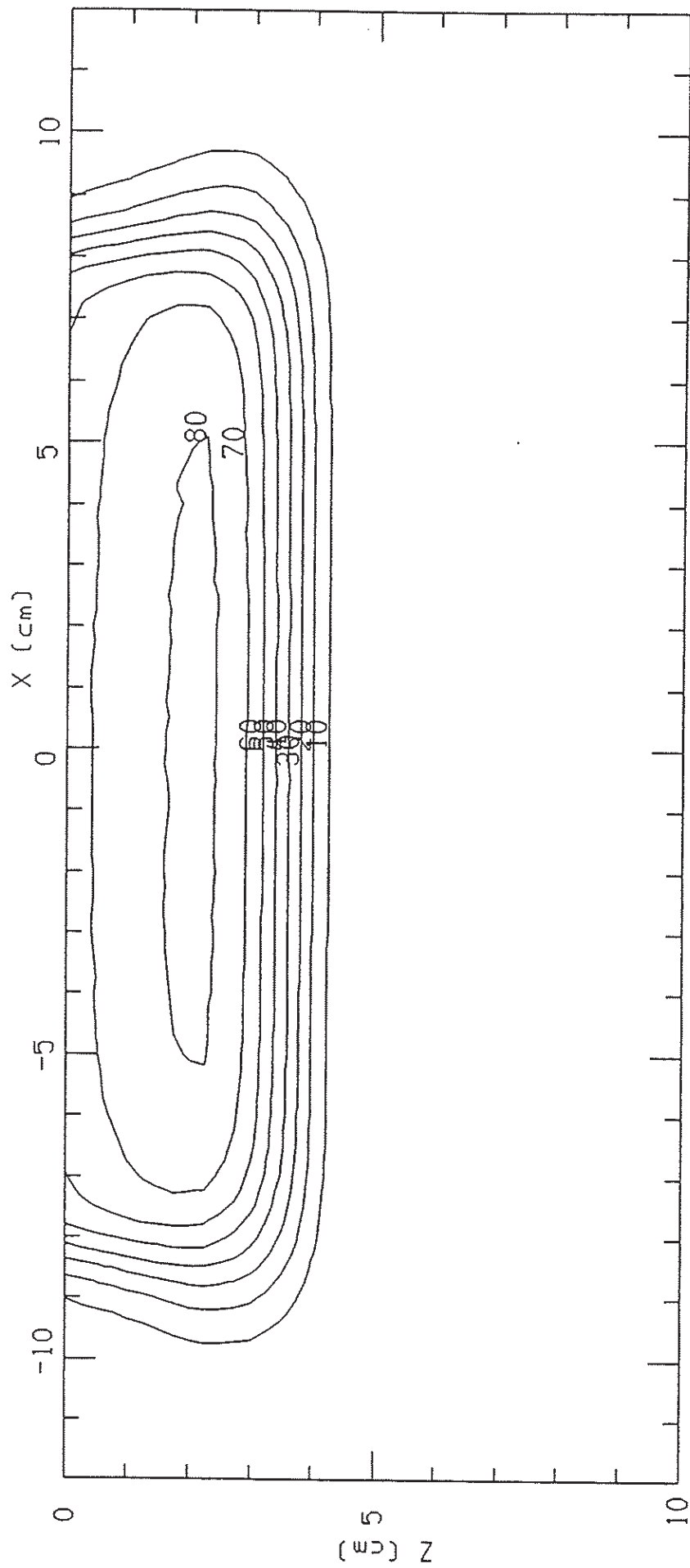

\* 8863

C062DM09060Y0000\_MOD.OUT

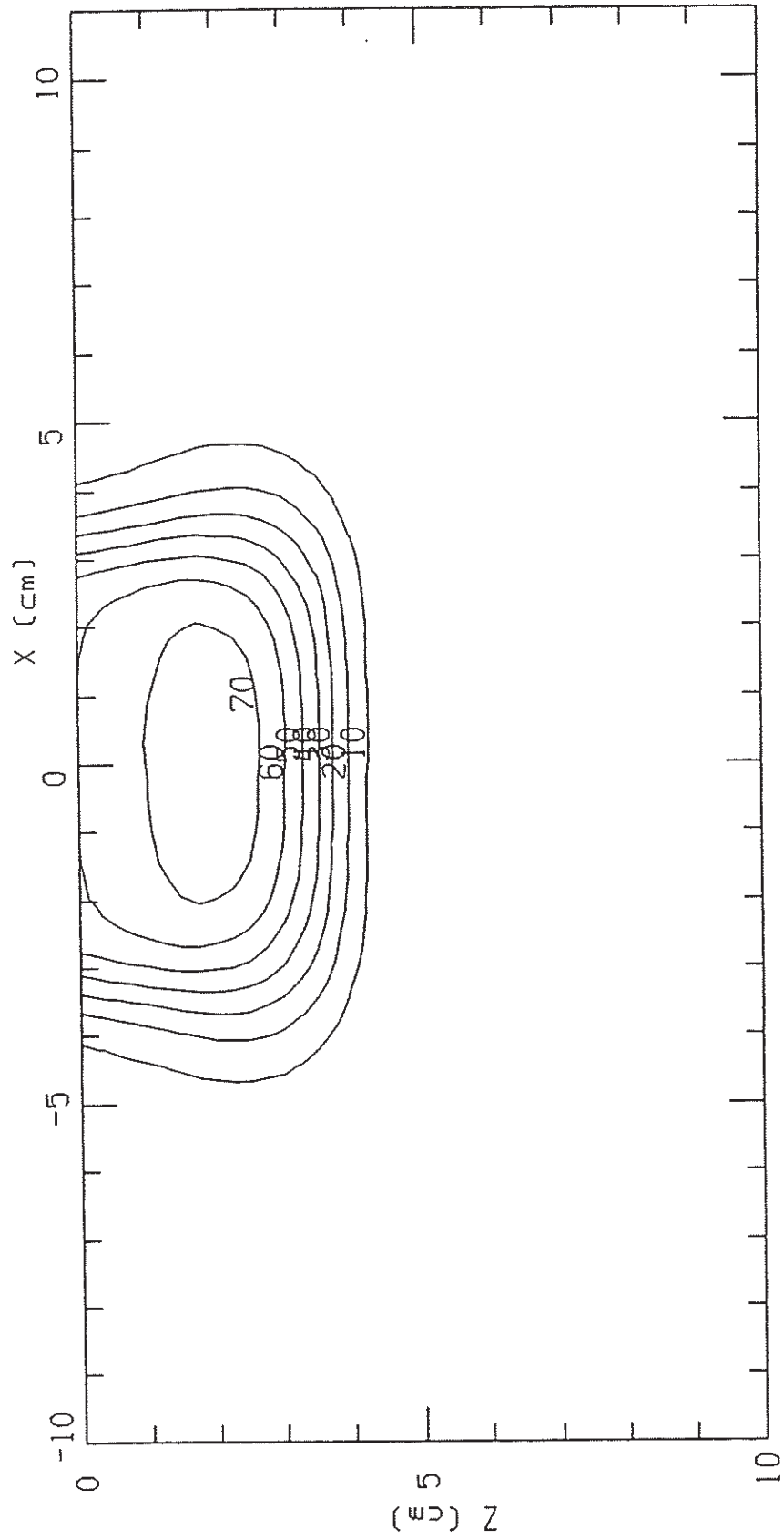

C072DM20150Y0000\_MOD.OUT

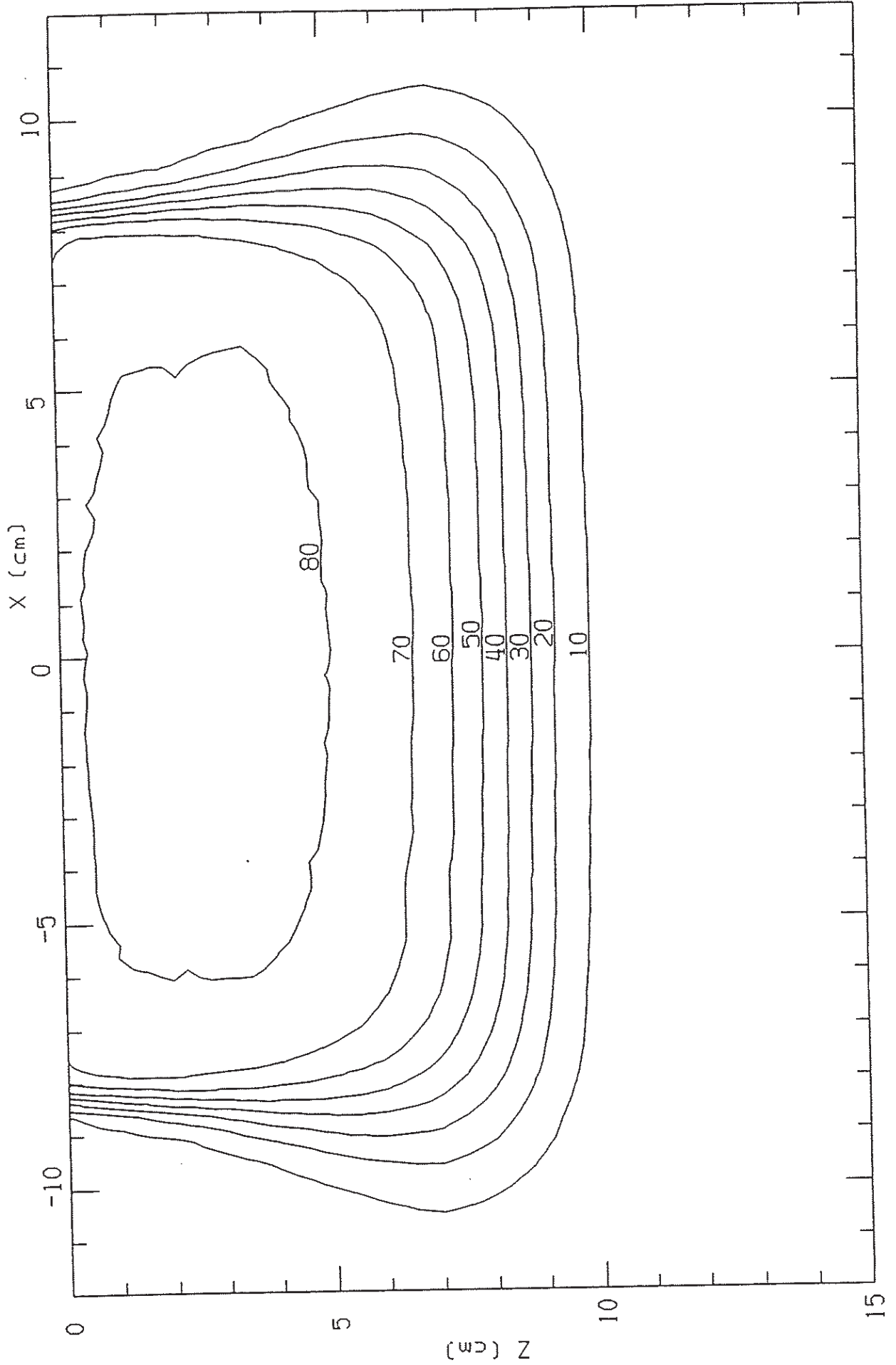

\* 8863

C082DM20060Y0000\_MOD. OUT

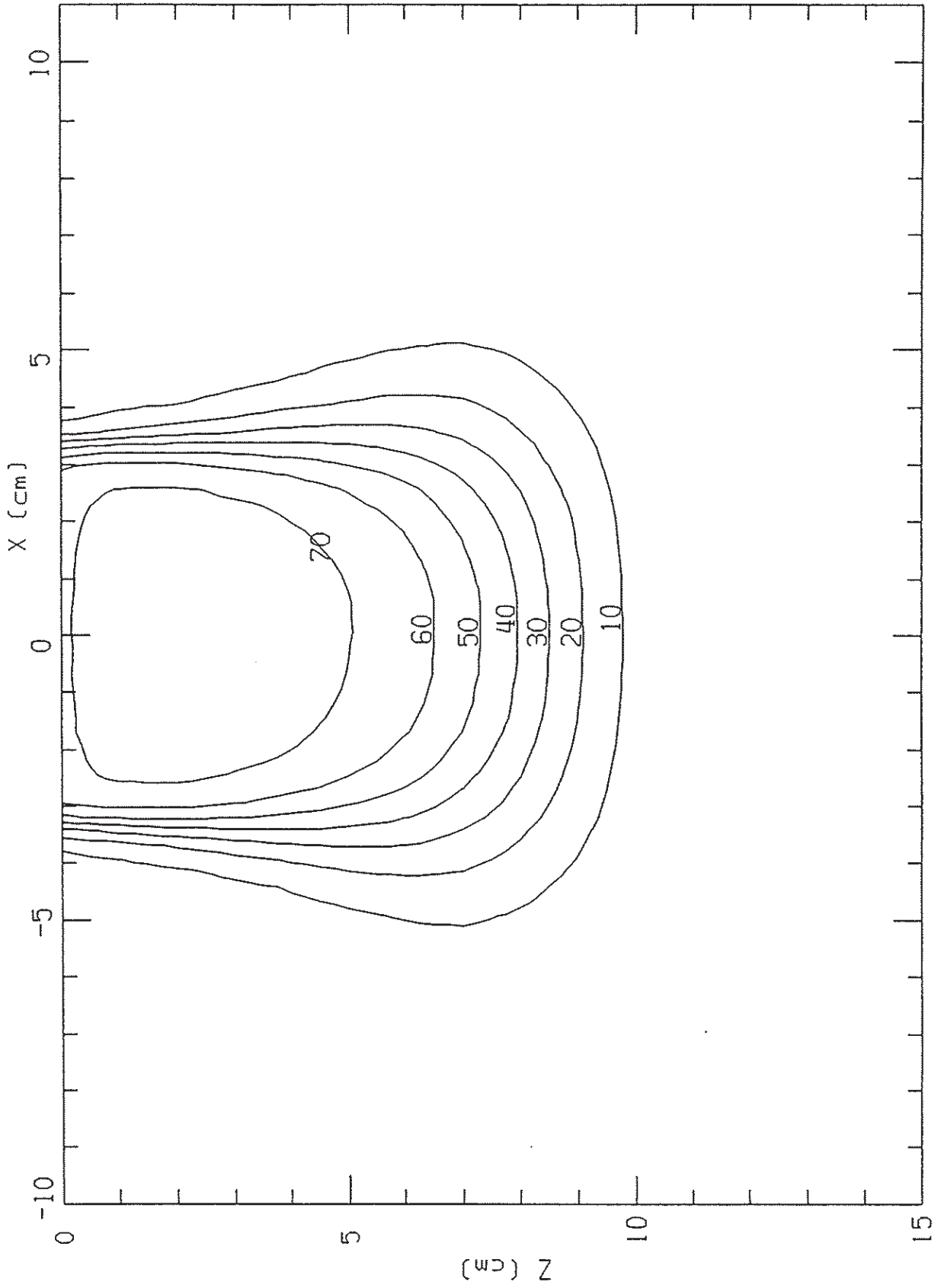

\* 8863

C092DM09030X0000\_MOD.OUT

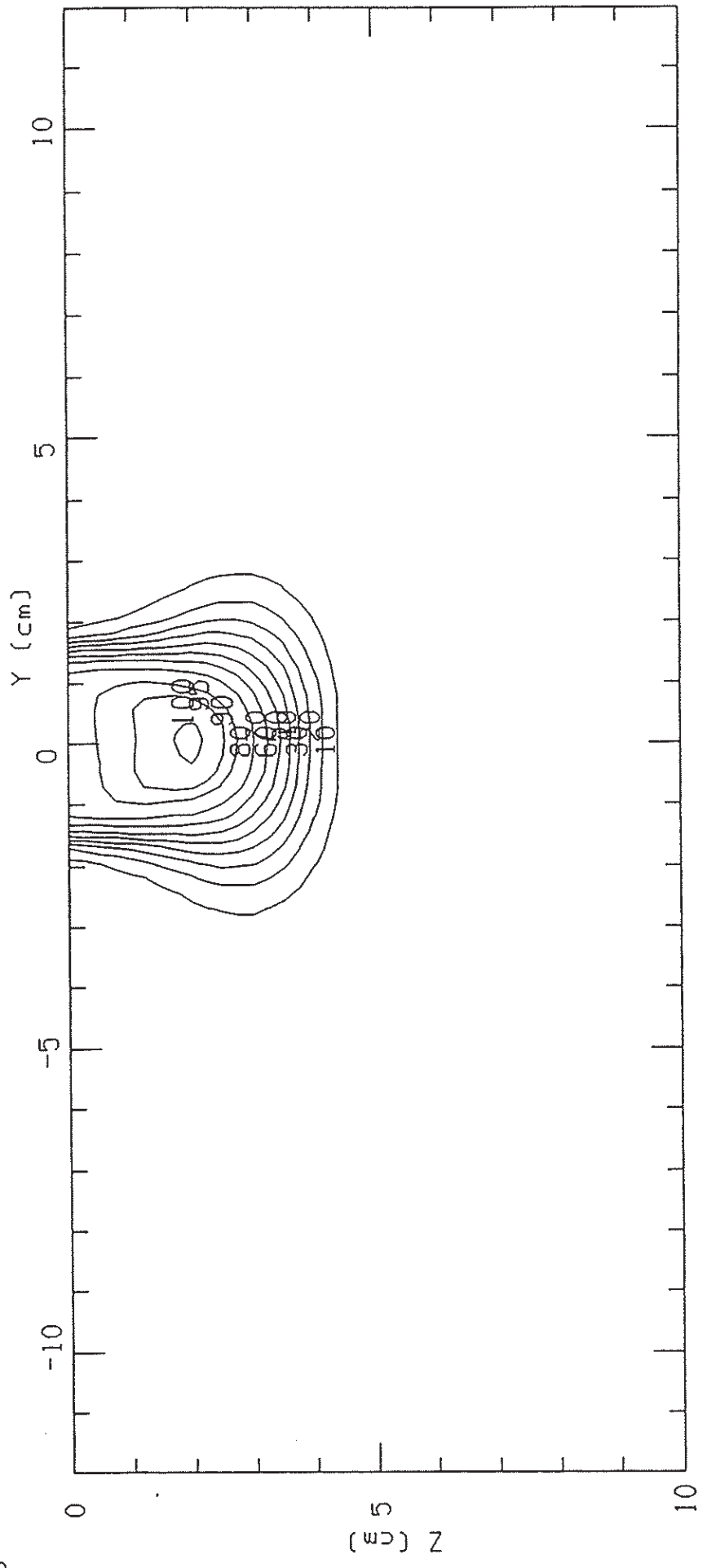

C092DM09120Y0000\_MOD.OUT

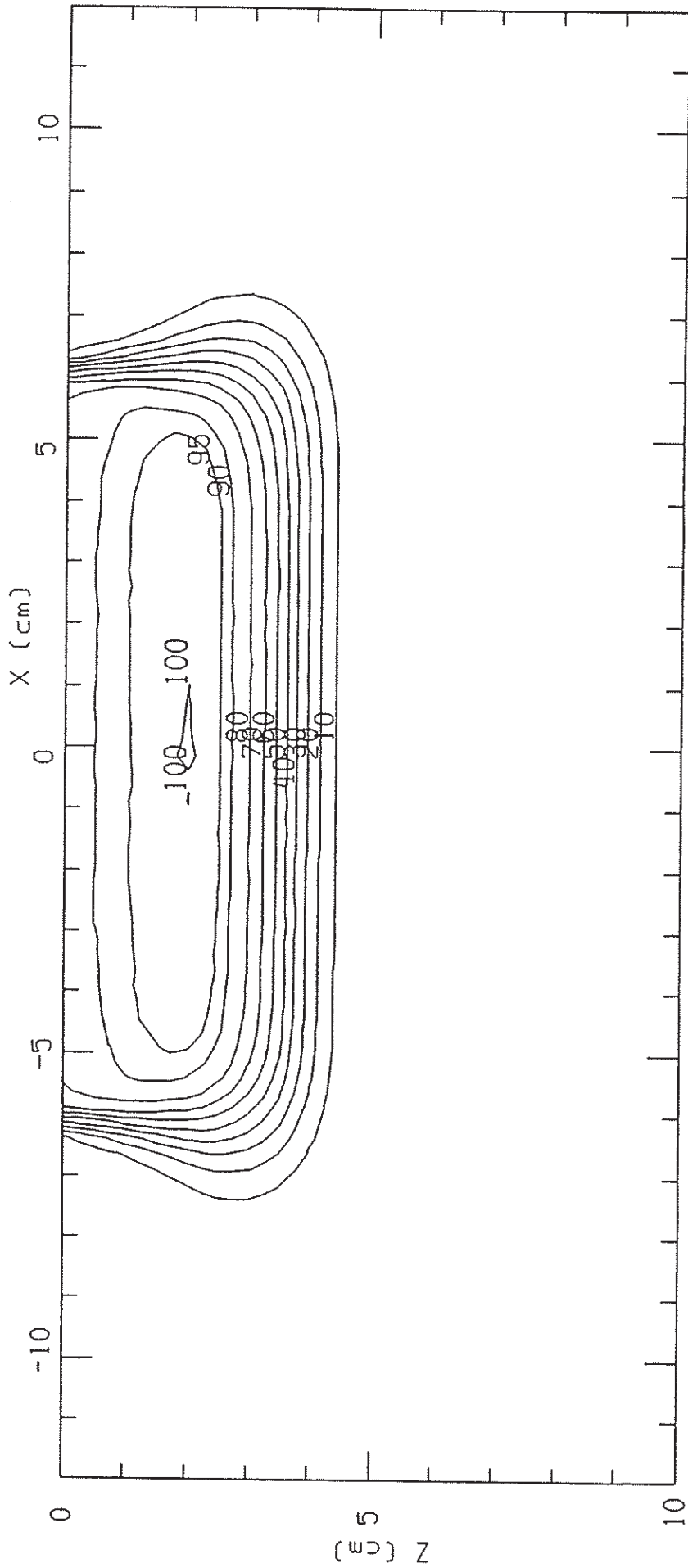

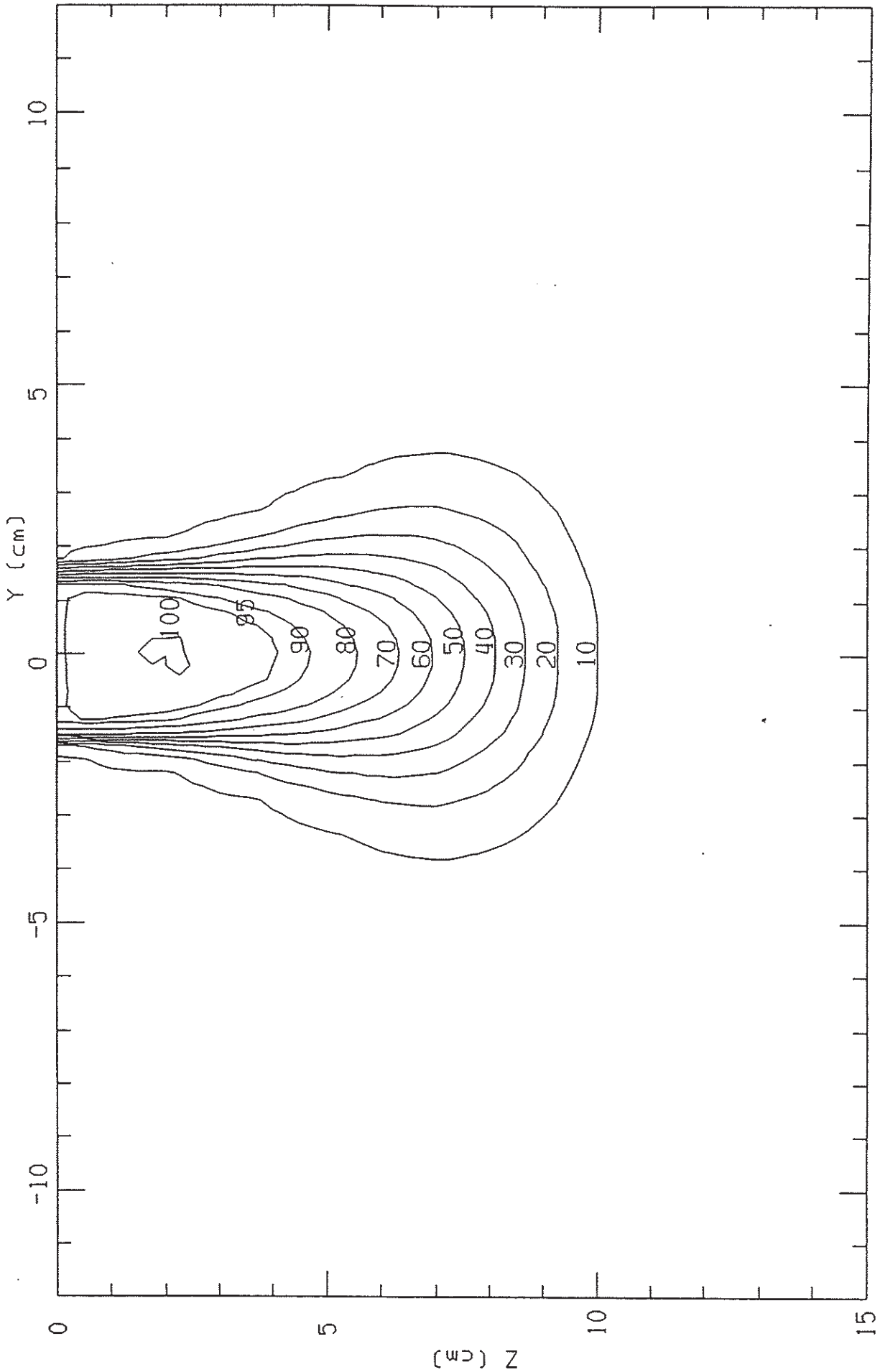

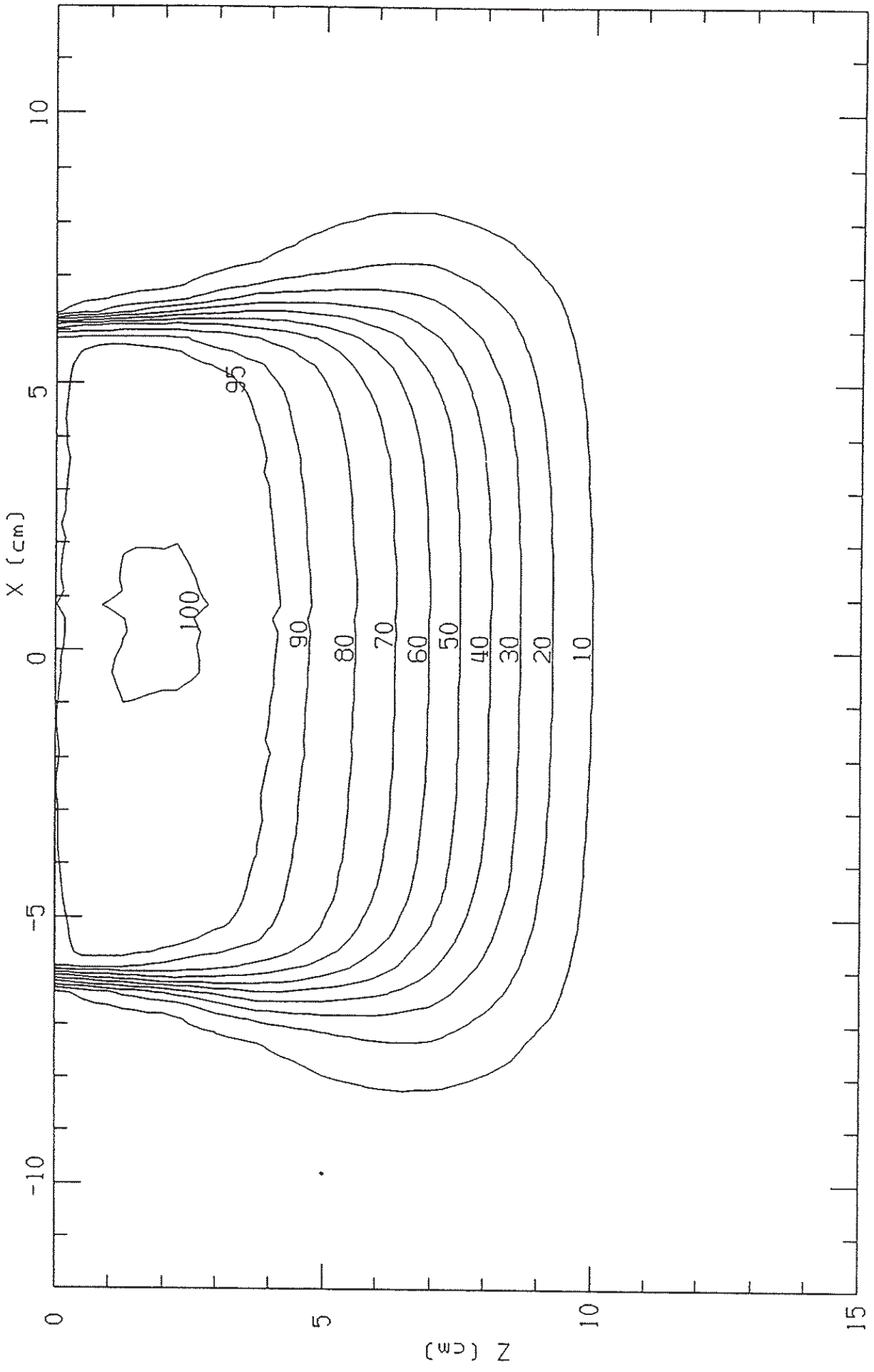

C112DM09IRRY0030.0UT

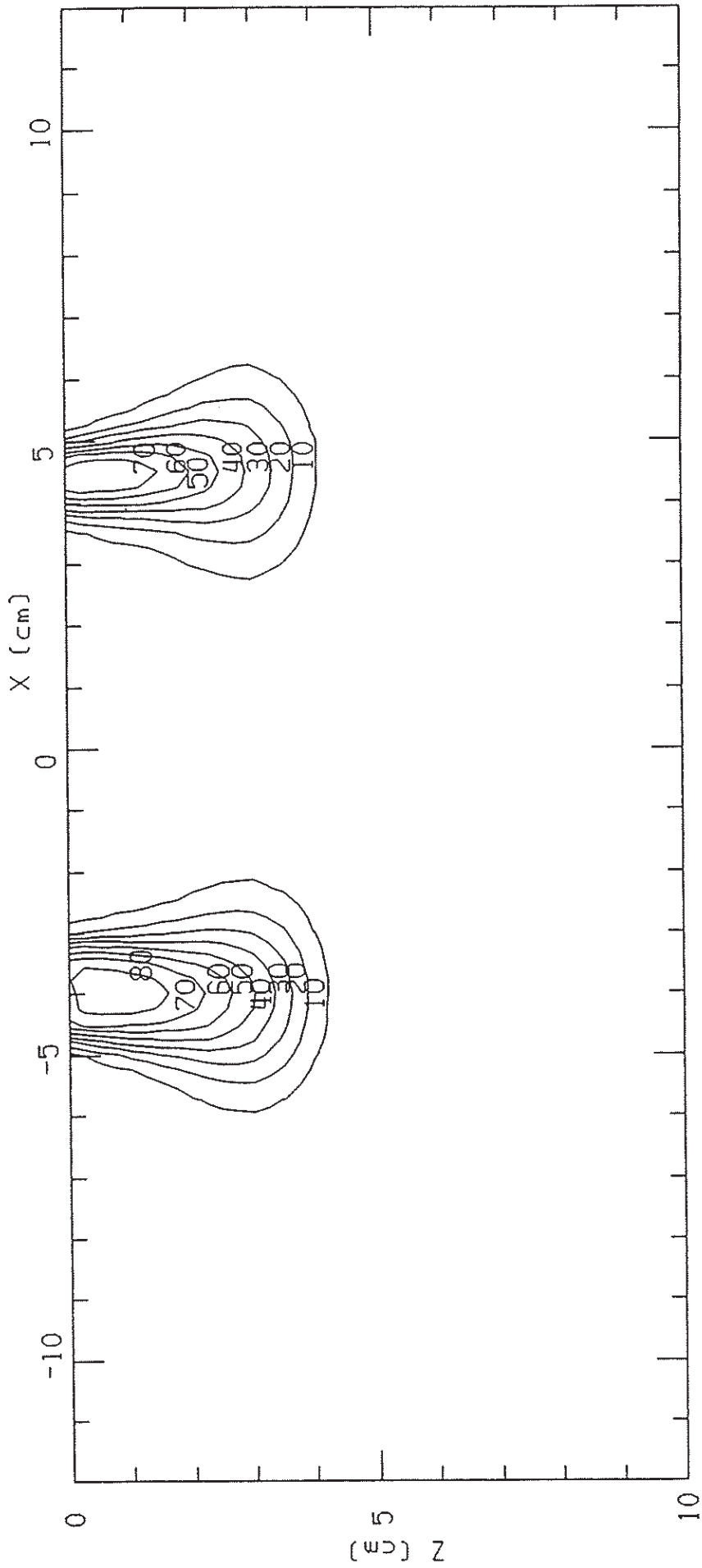

C112DM09IRRY\_030.OUT

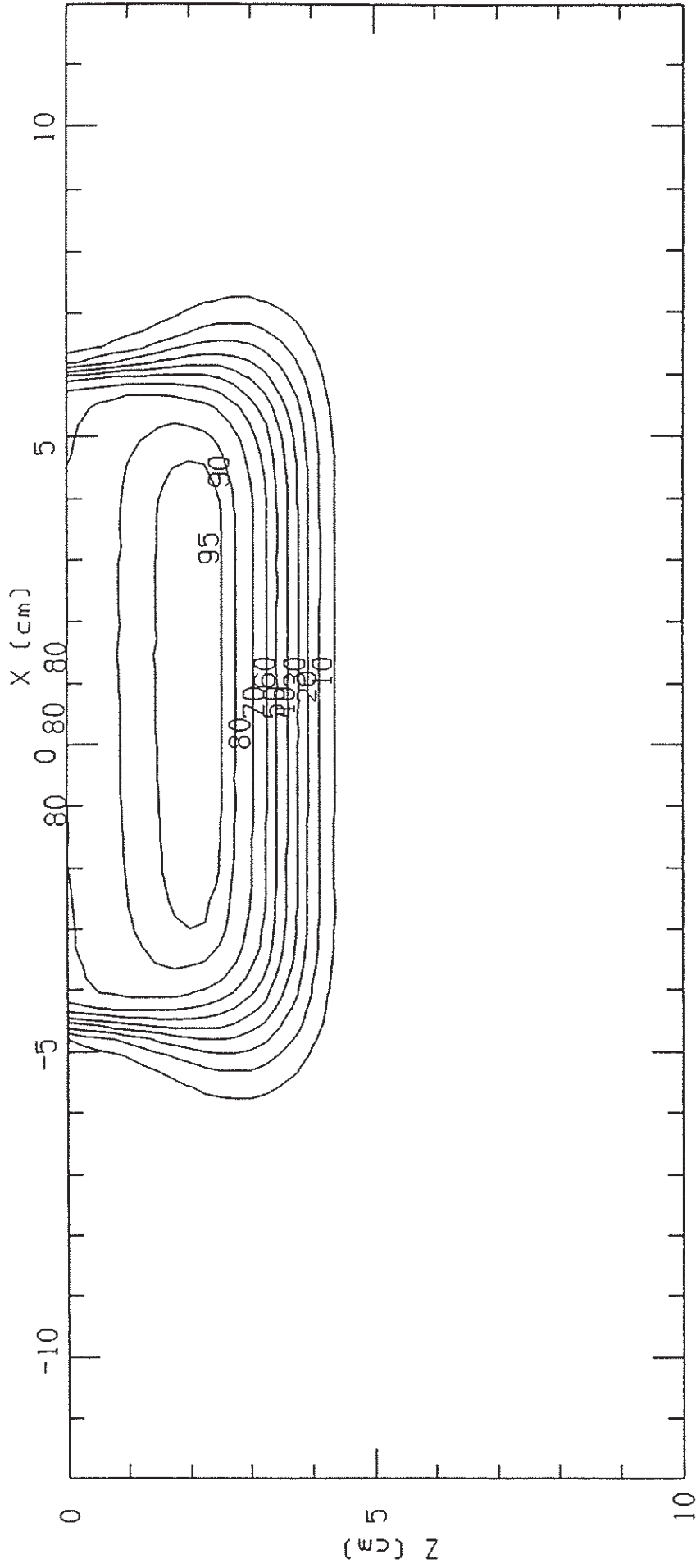

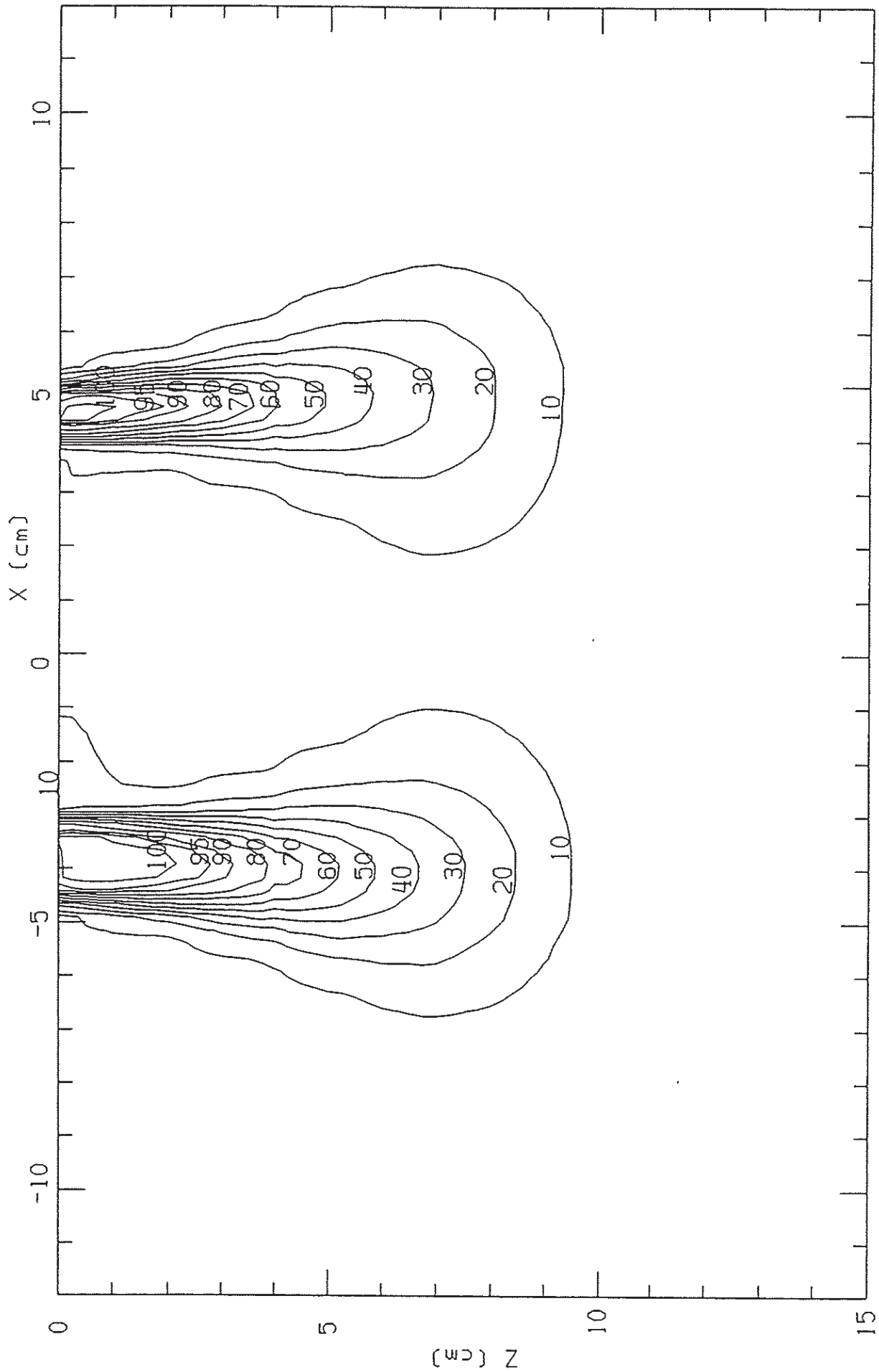

C122DM20IRRY\_030\_MOD. OUT

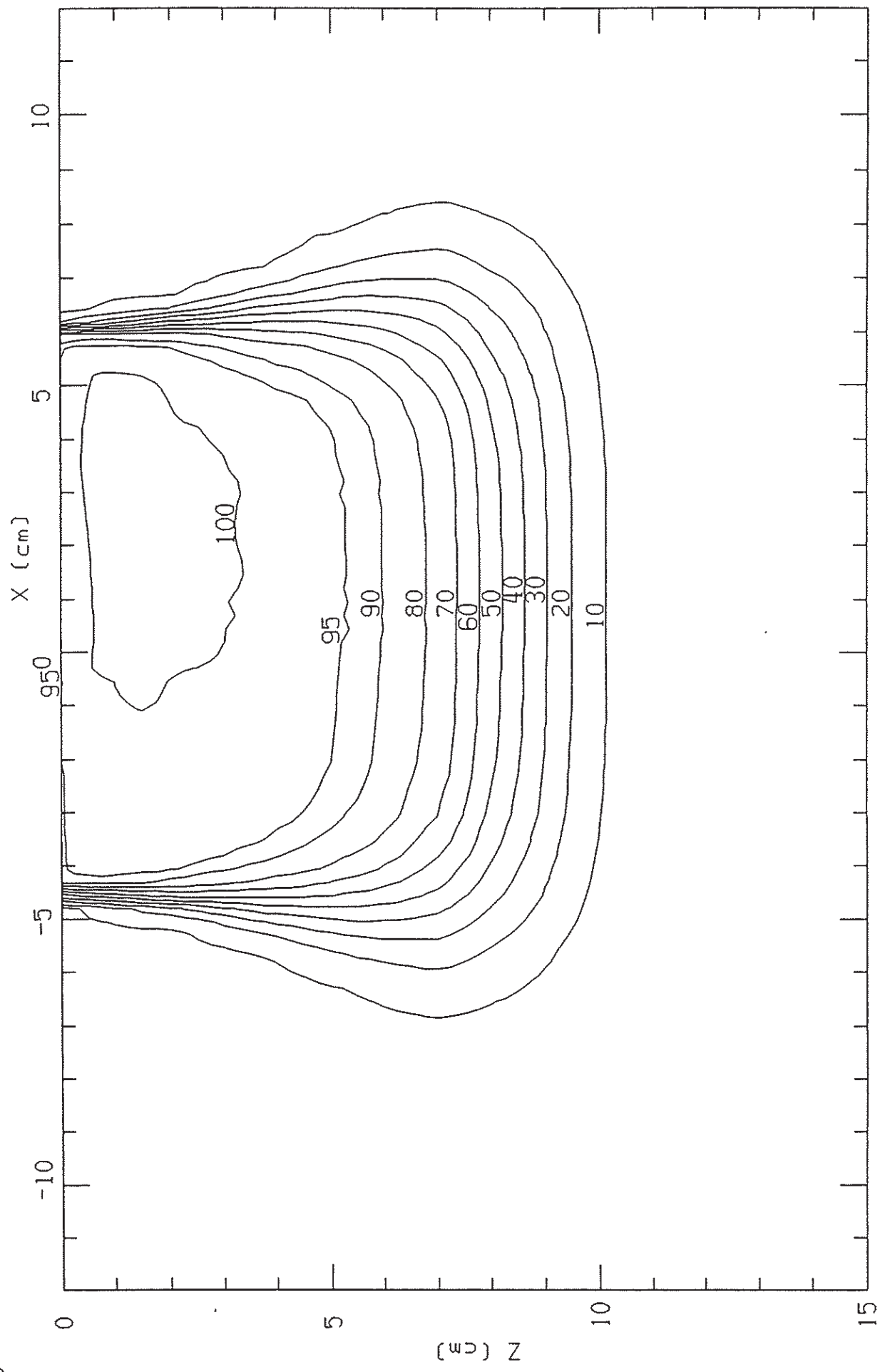

C132DM20050X0000\_MOD. OUT

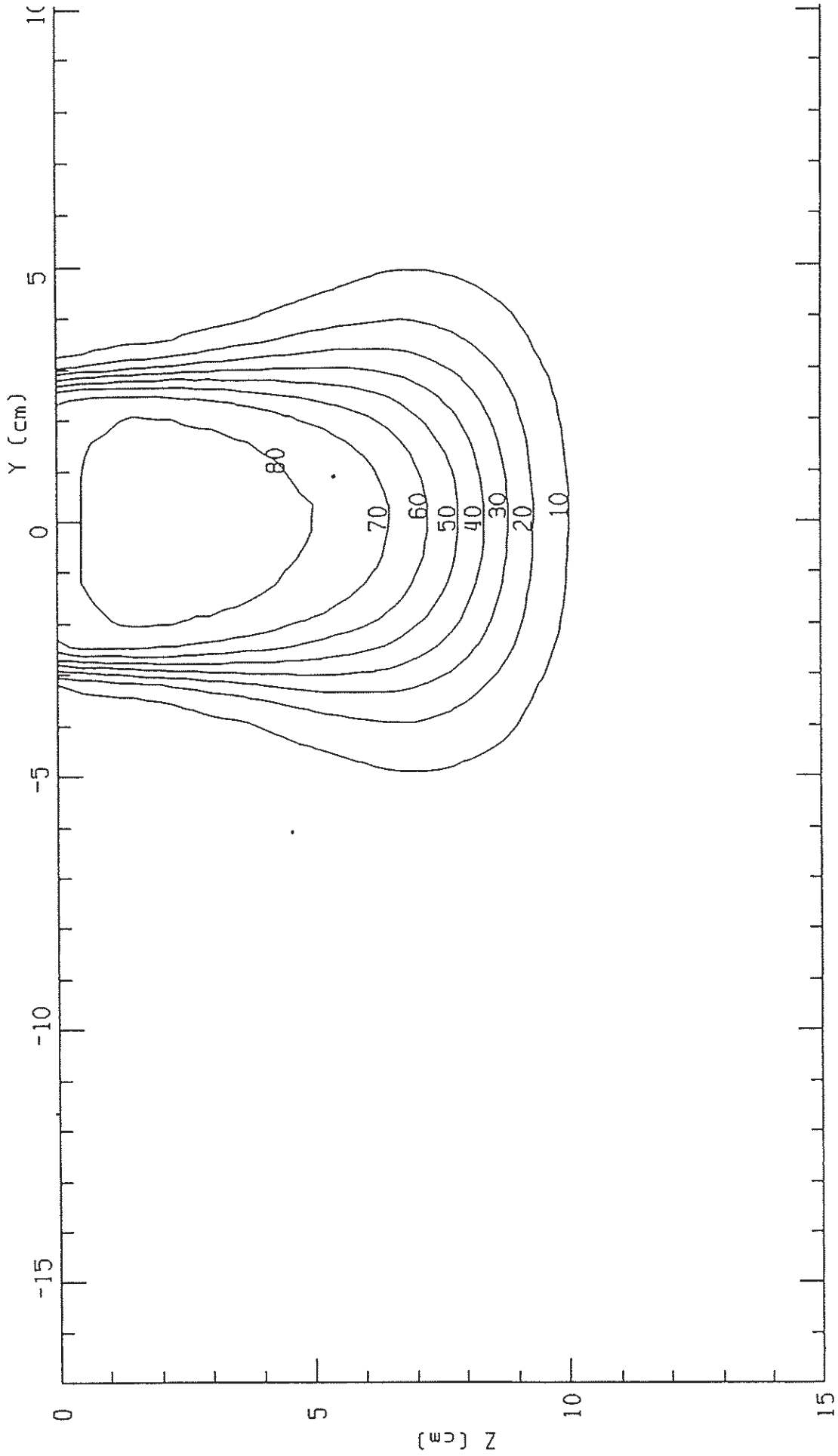

C132DM20050X0140\_MOD.OUT

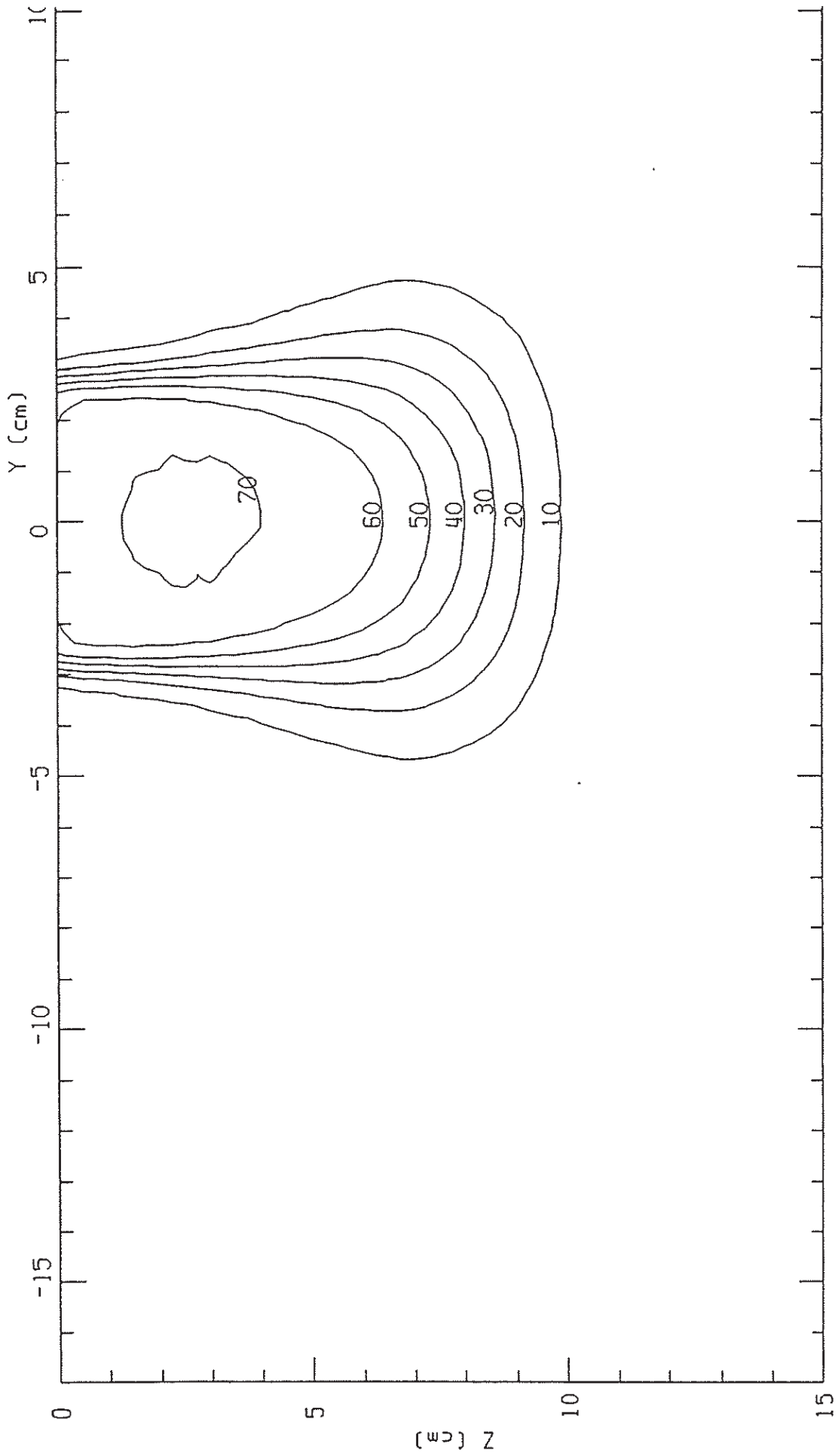

C1320M20300Y0000\_MOD. OUT

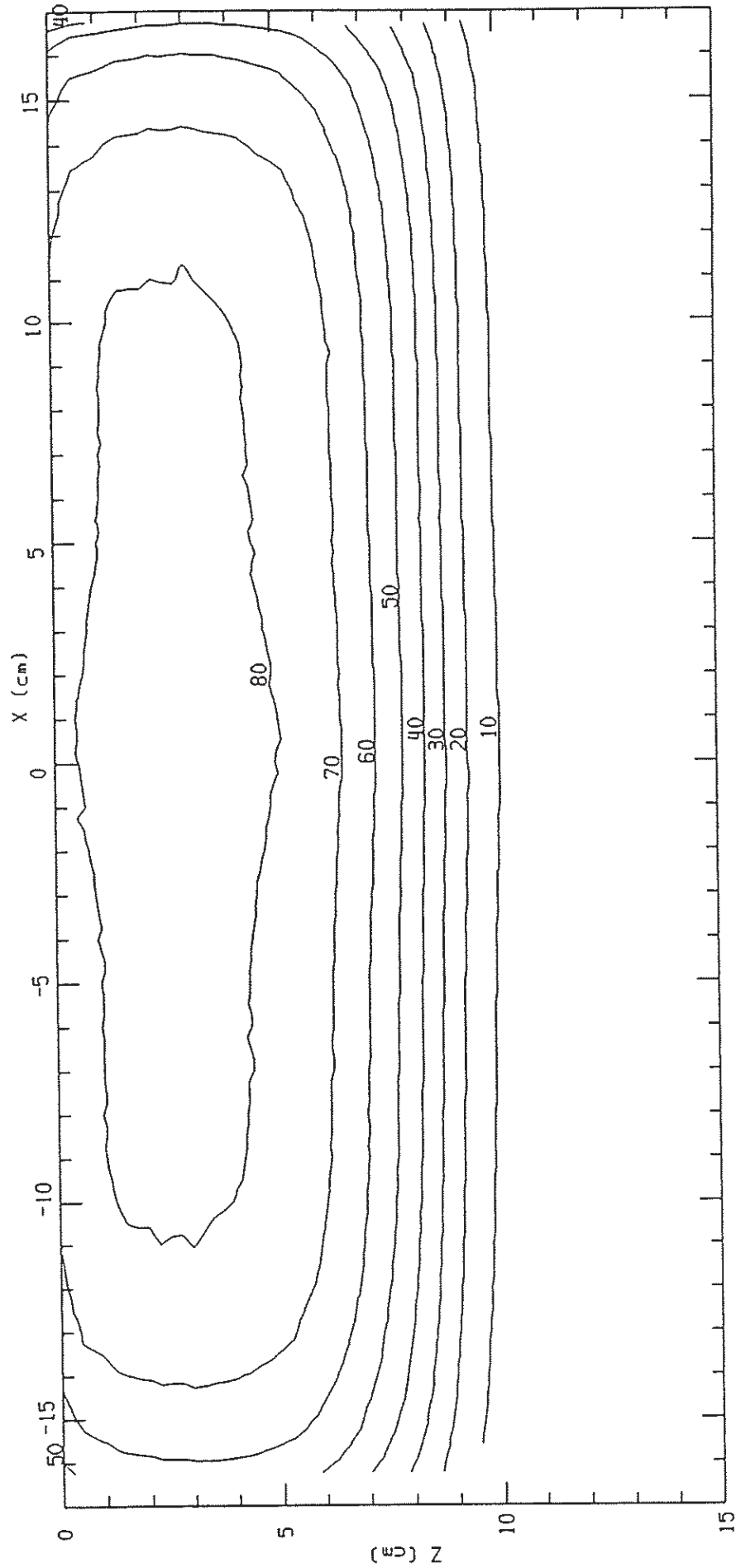

\* 8988 \*

C142DM09EY0000\_MOD.OUT

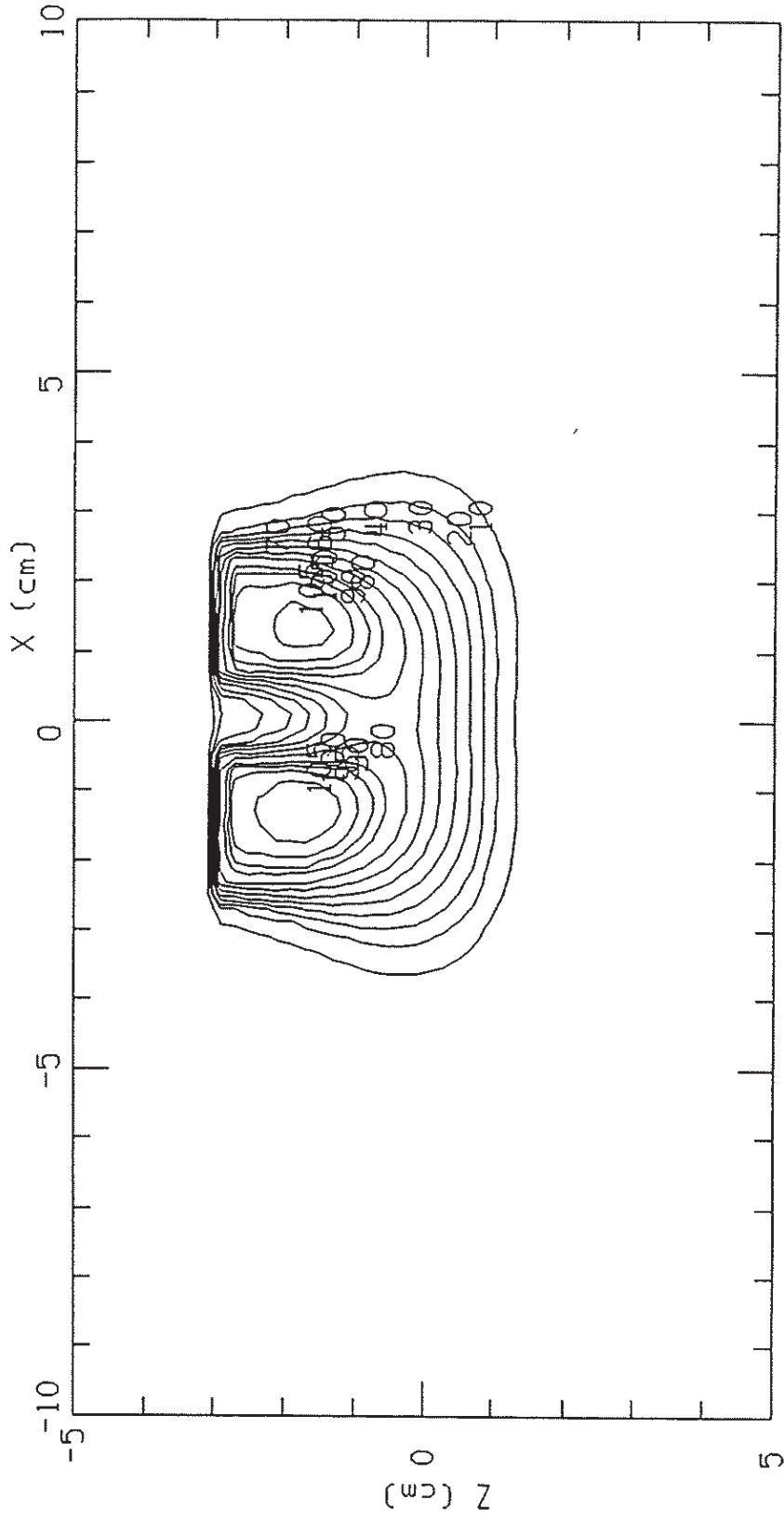

C152DM09150Y0000\_MOD.OUT

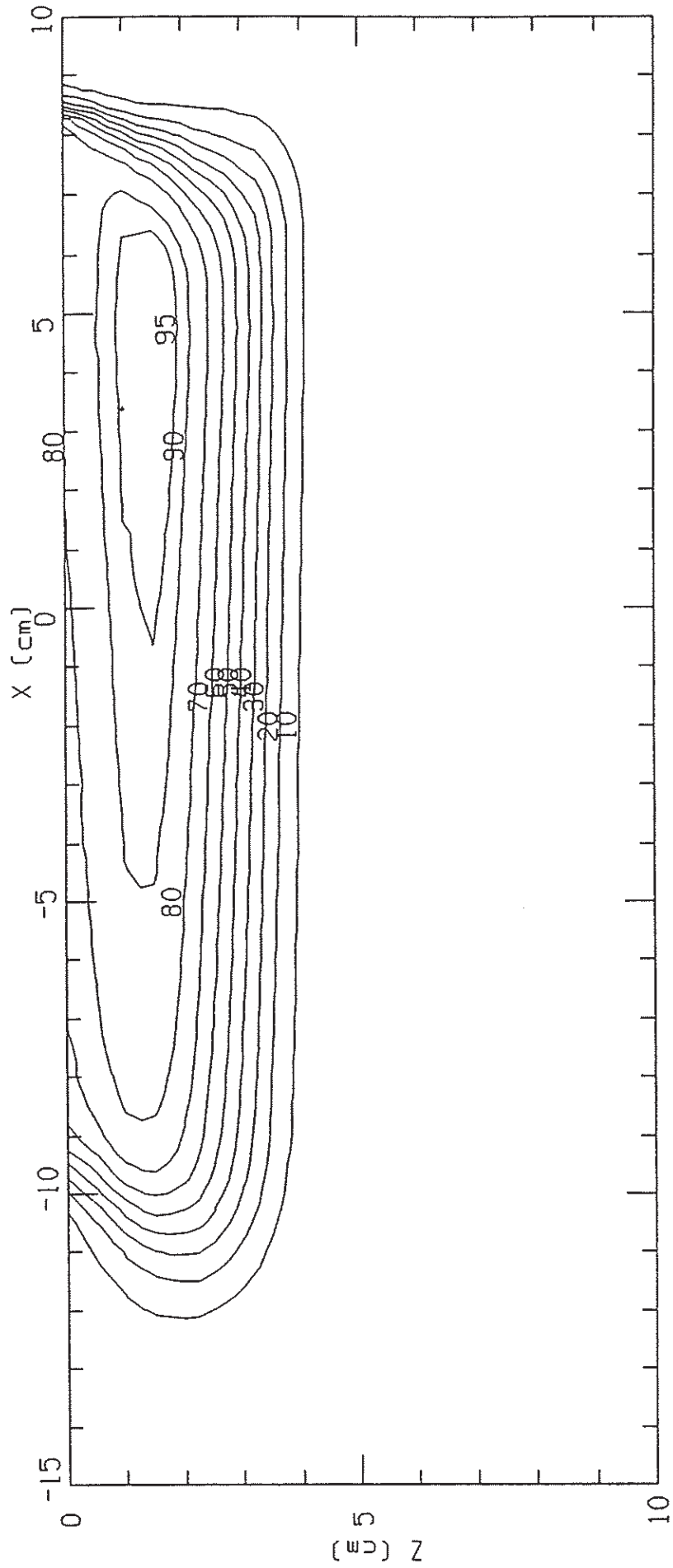

C162DM20150Y0000\_MOD.OUT

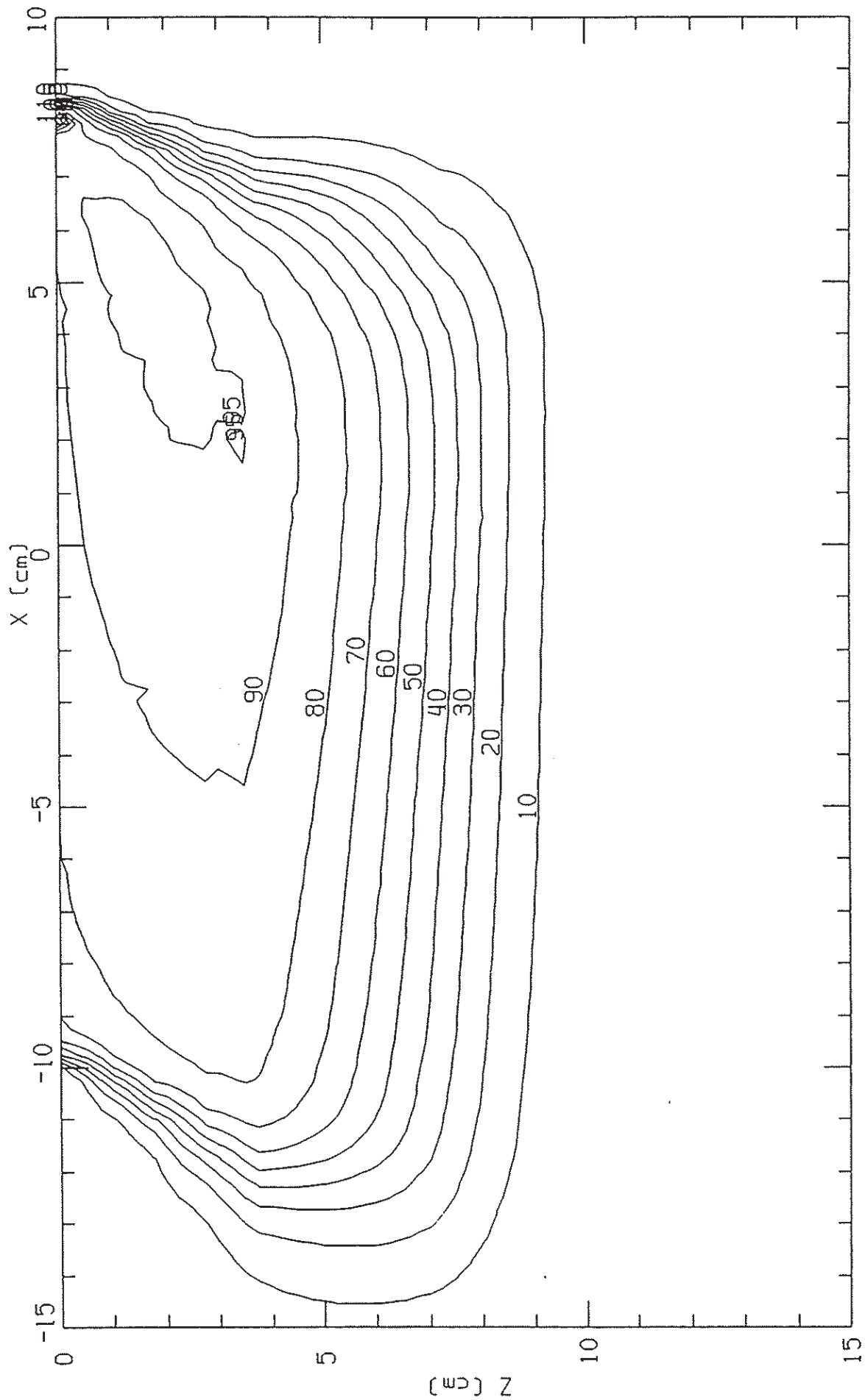

C172DM09150X0010\_MOD.OUT

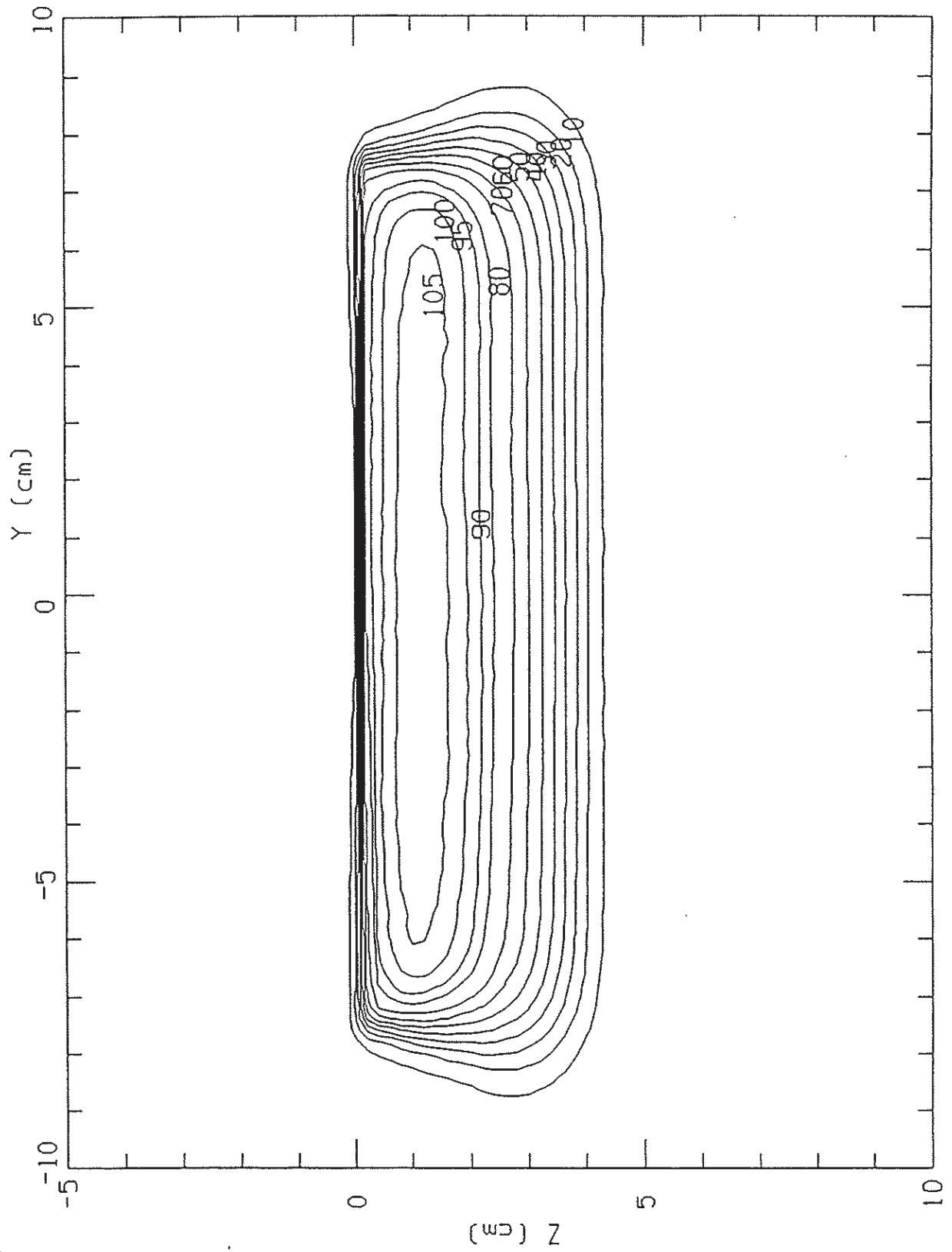

C172DM09I50Y0000\_MOD.0UT

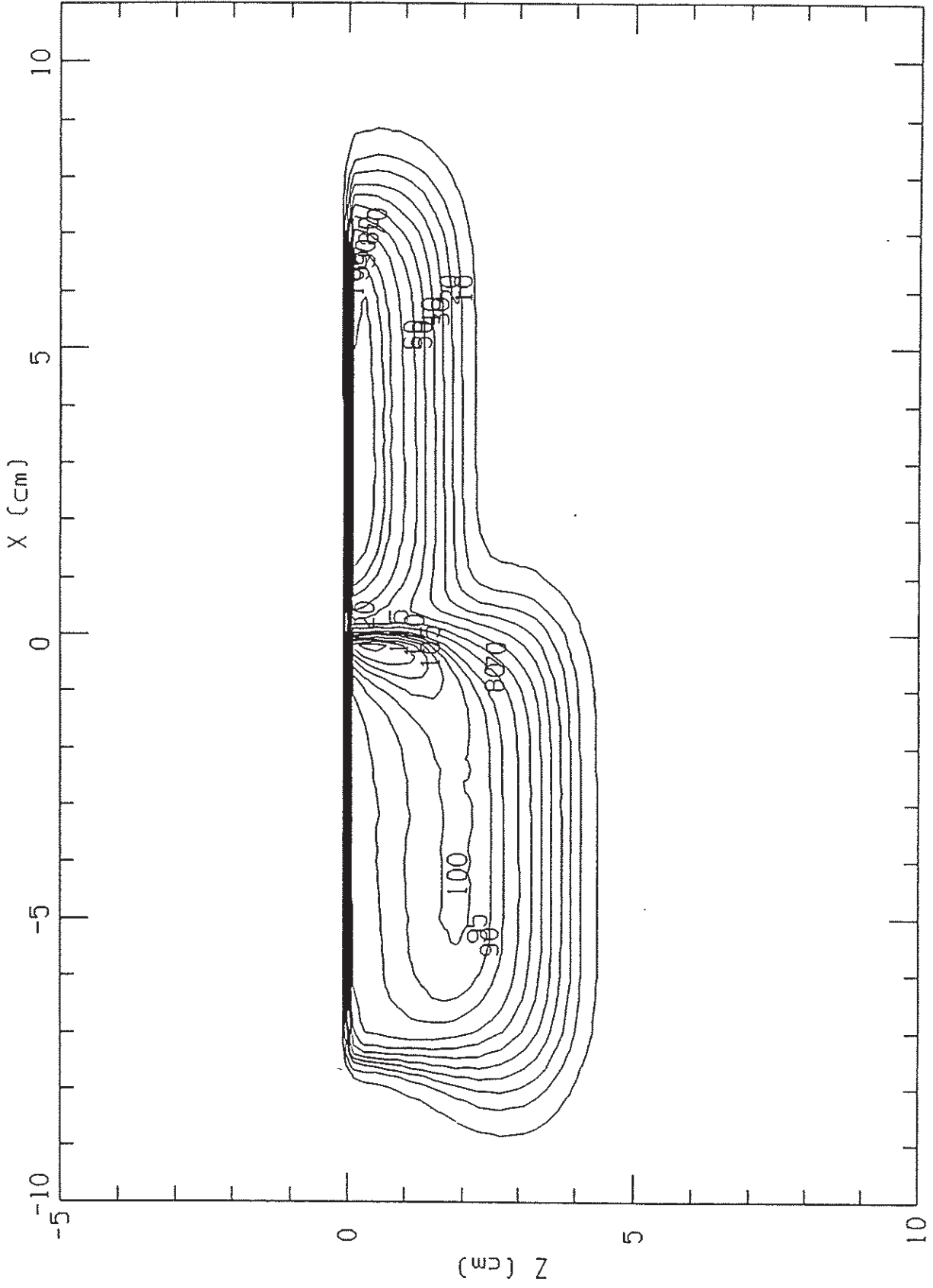

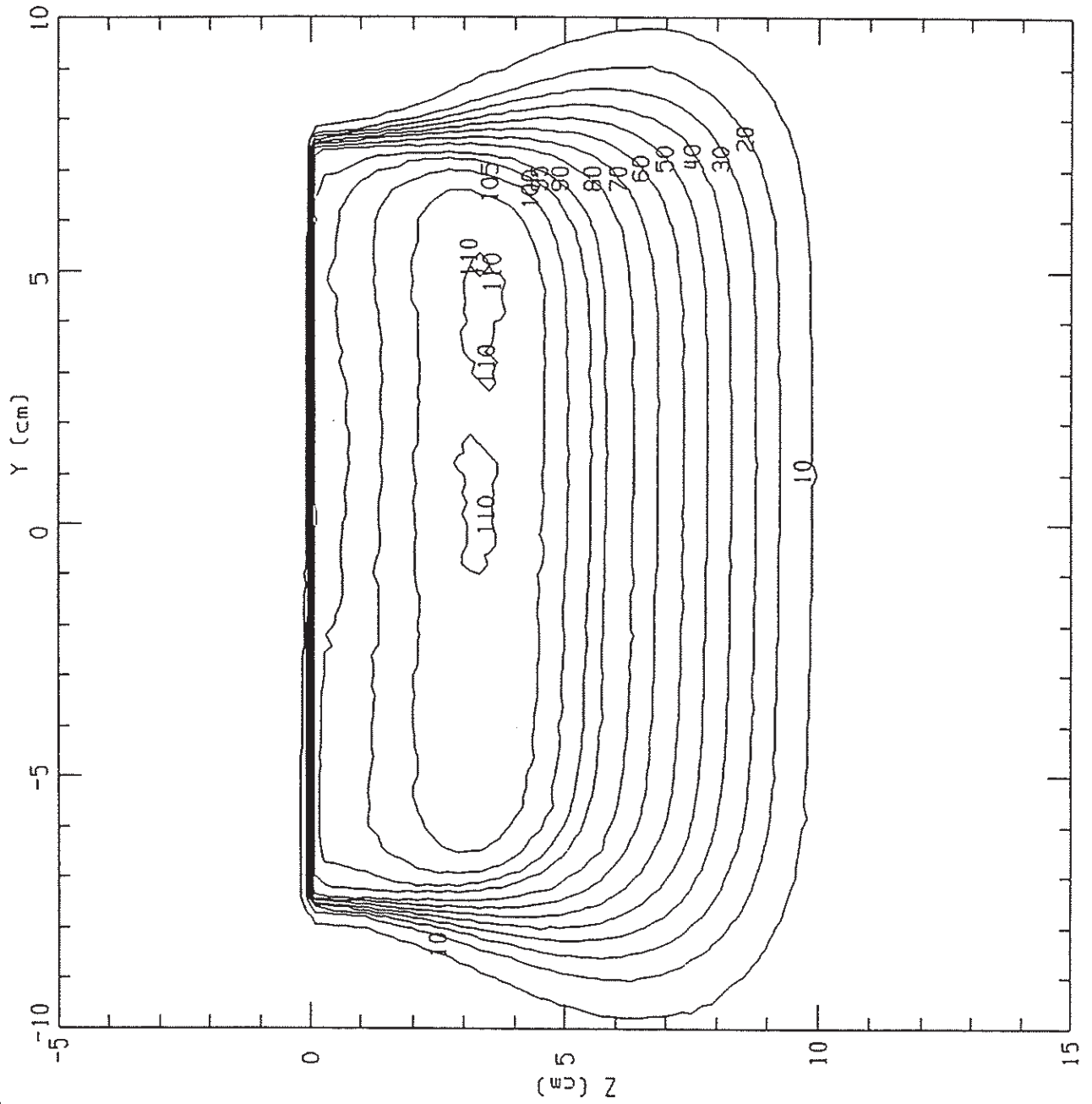

\* 8863

C182DM20150Y0000\_MOD. OUT

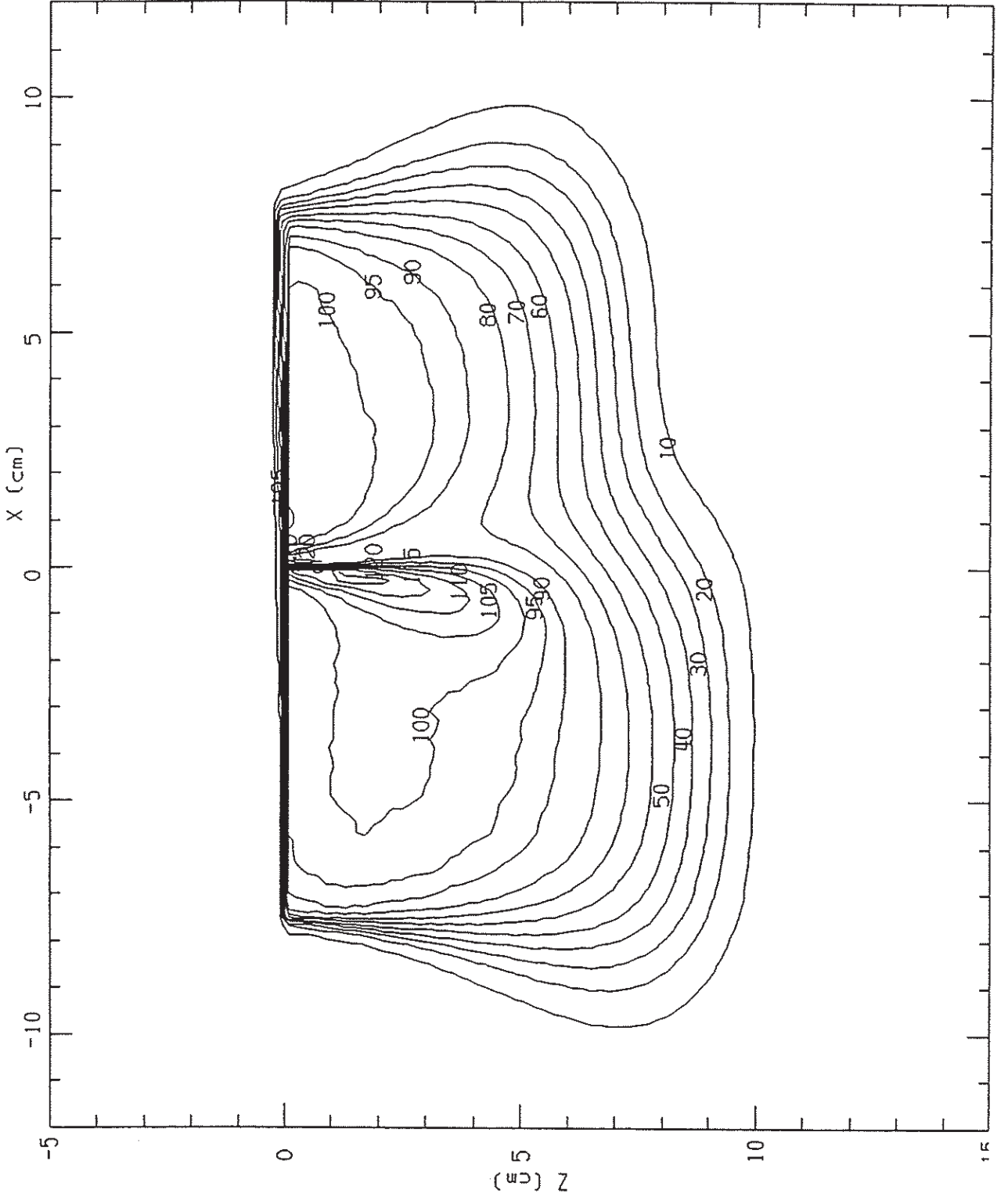

C192DM09150Y0000\_MOD.0UT

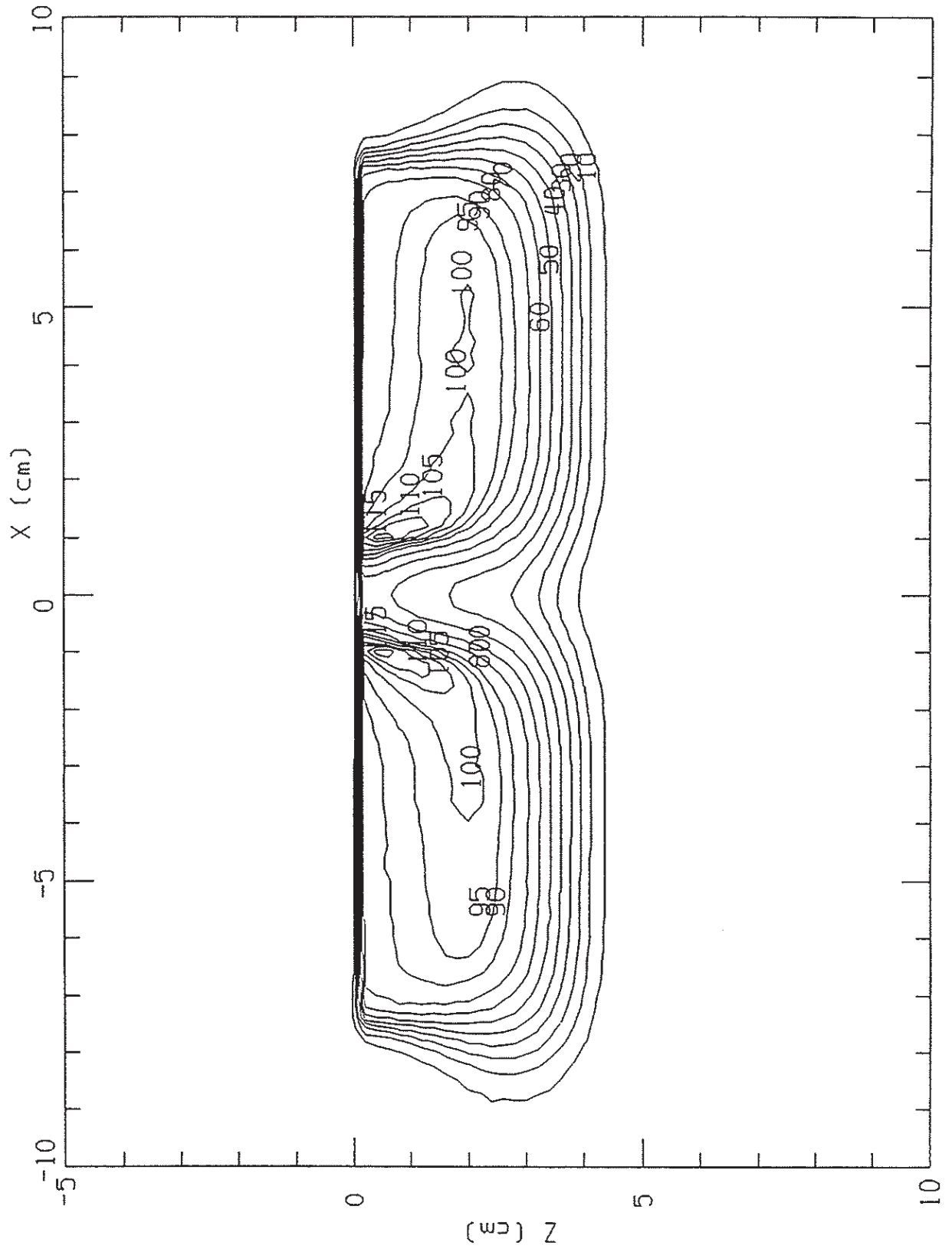

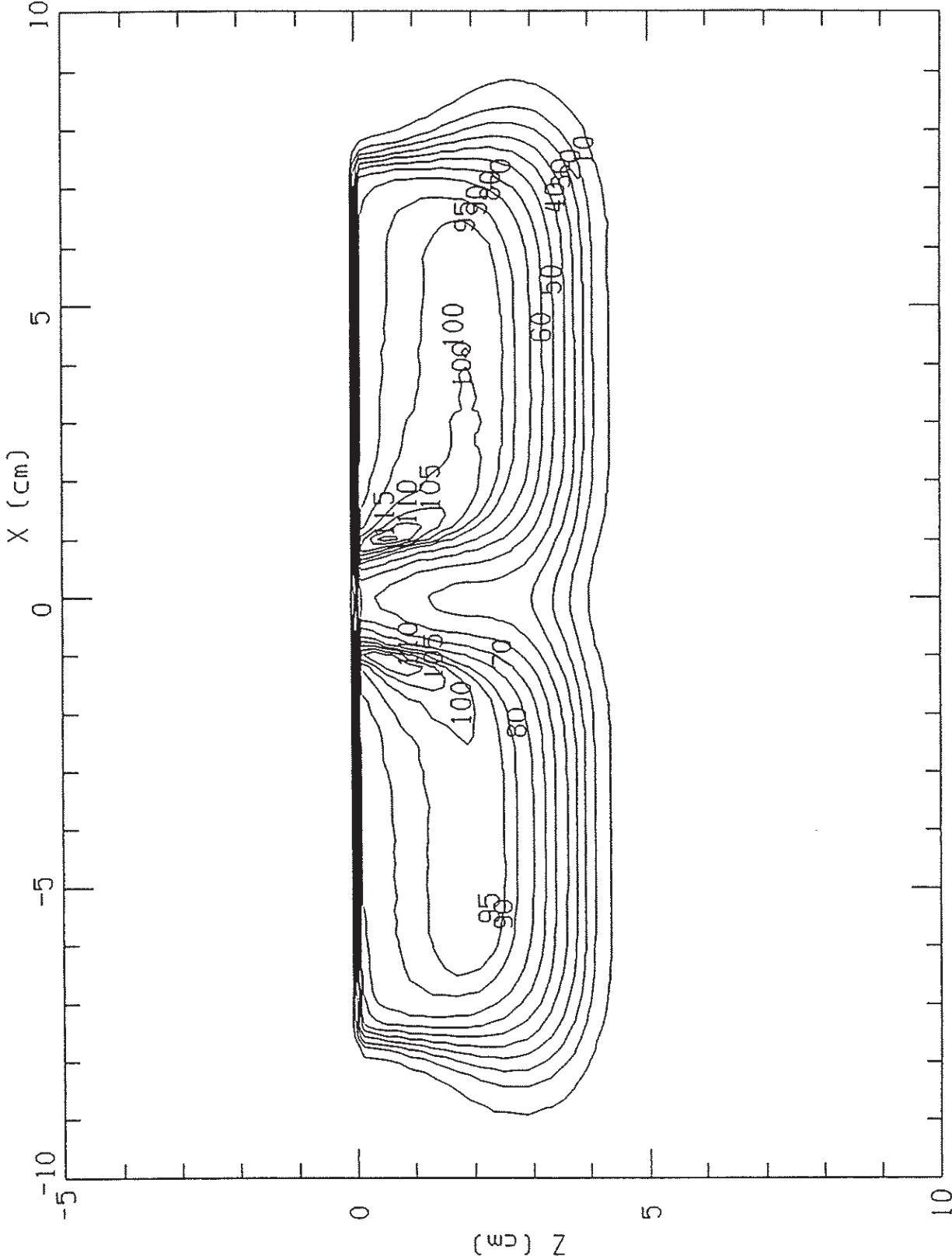

\* 8863

C192DM09150Y\_030.OUT

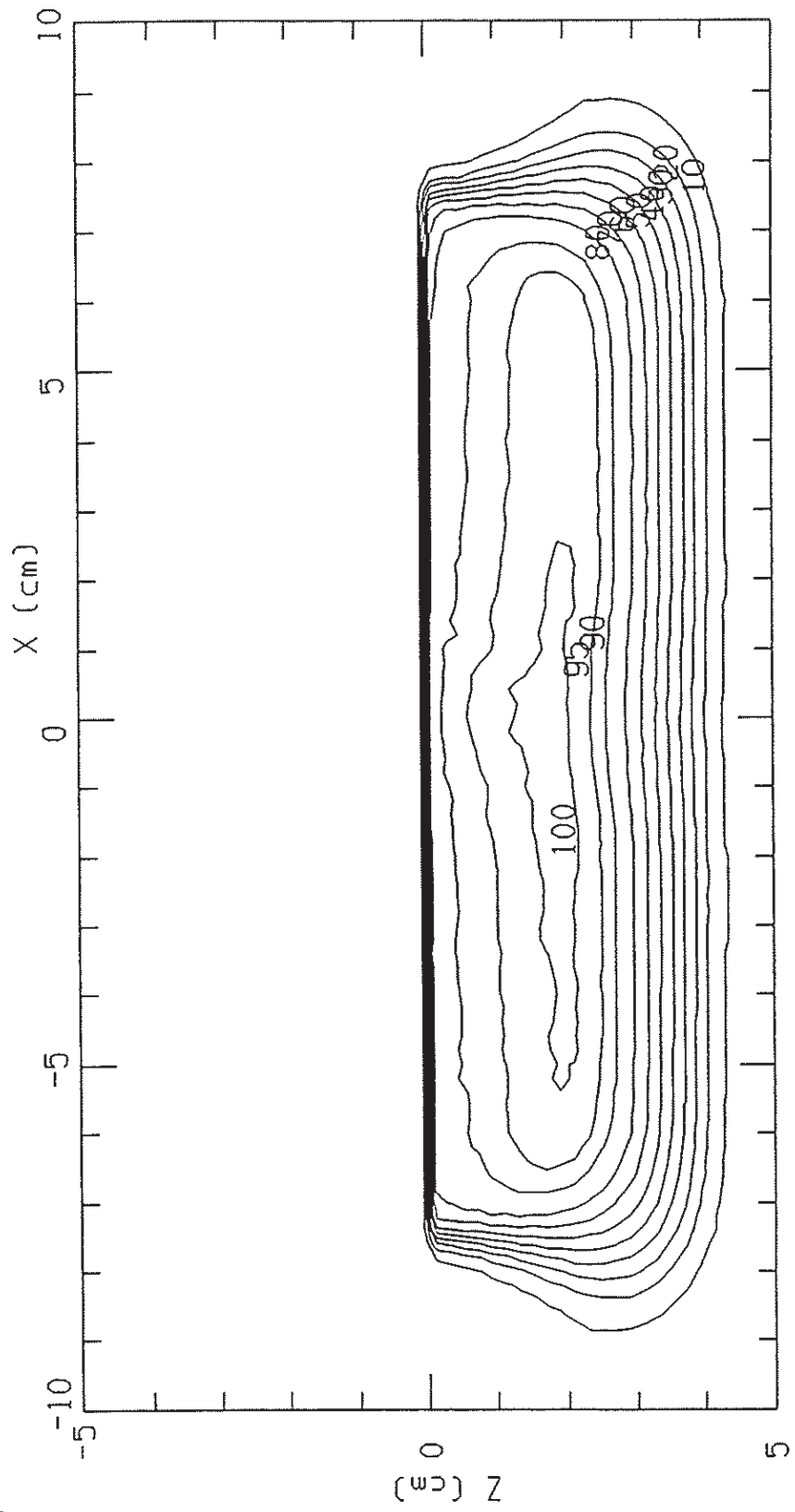

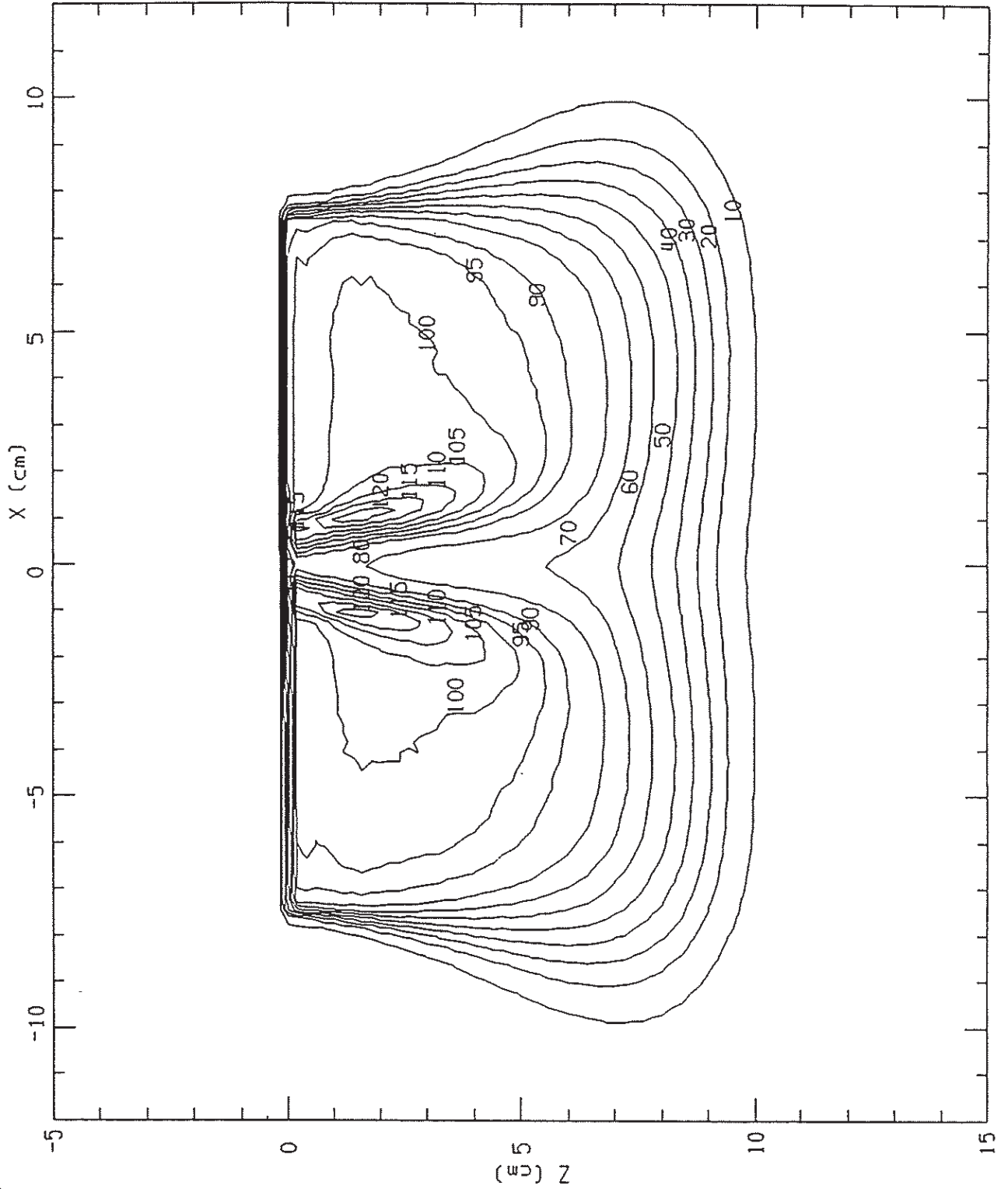



C2020M20150Y\_030\_MOD. OUT

8863

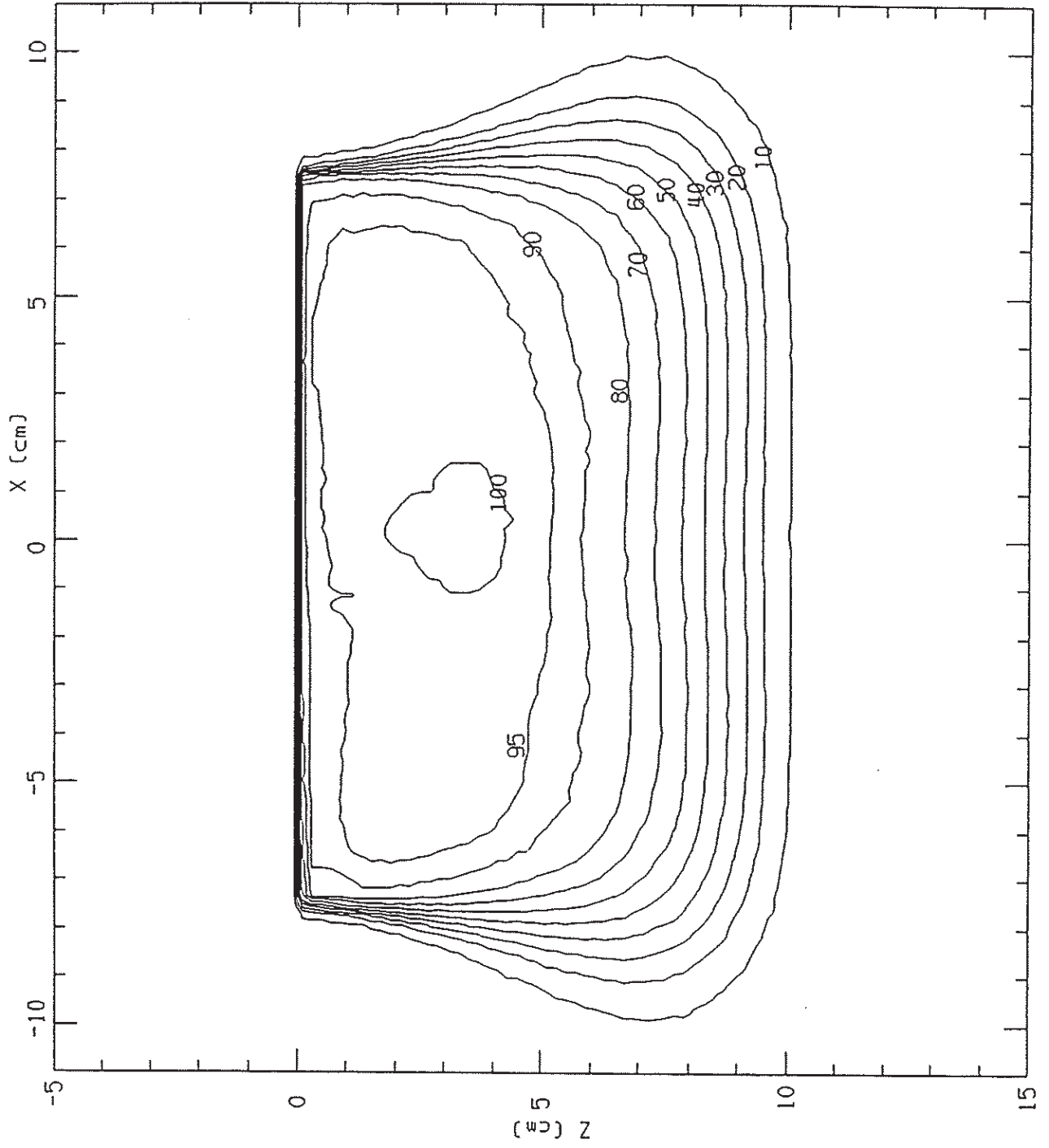

MACHINE: CLINAC 1800      SSD(CM): 100.0

C21FDD09150.OUT      FIELD: 15.0 x 15.0 cm

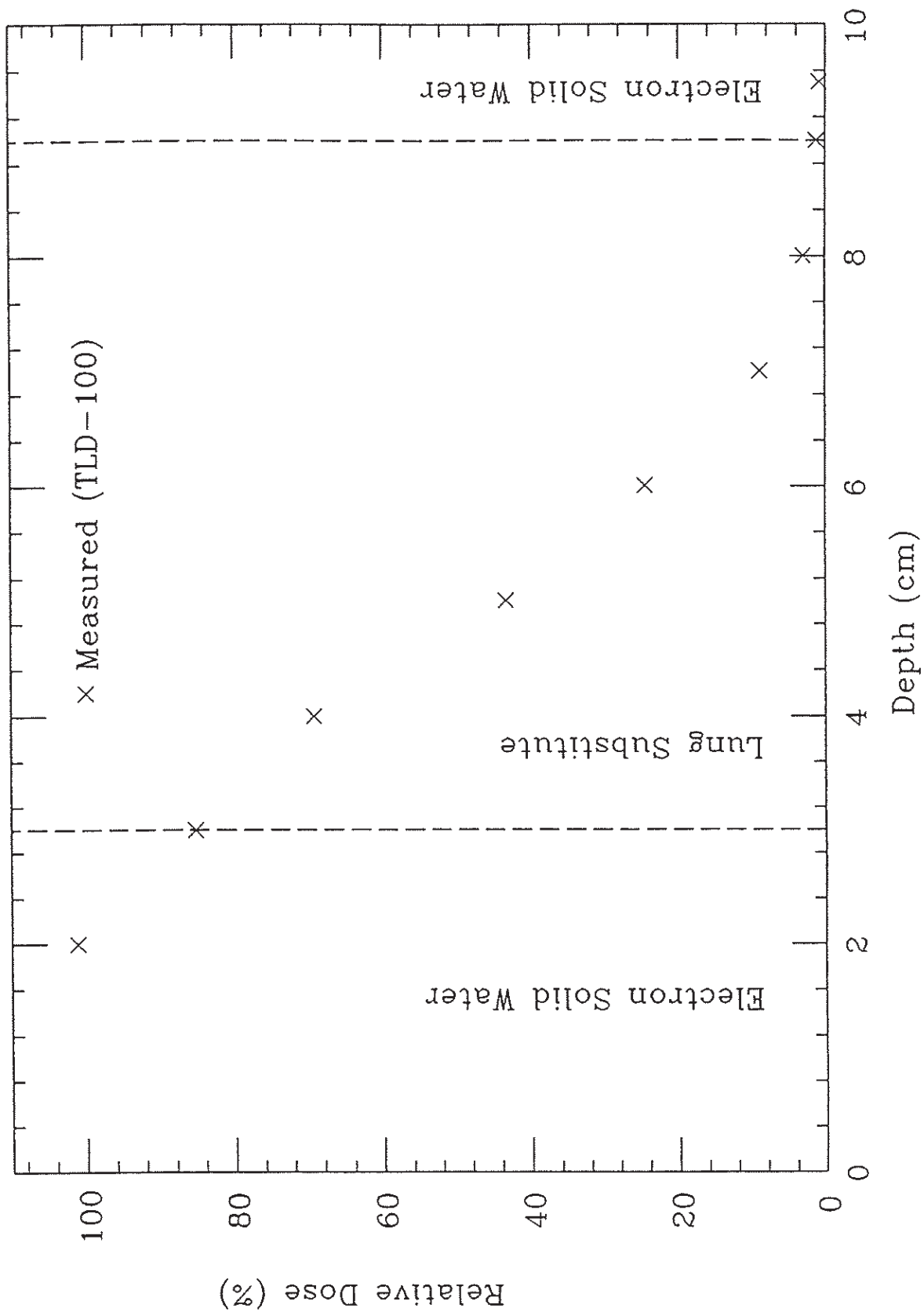

\* 8863

C2220M20150Y0000\_MOD.OUT

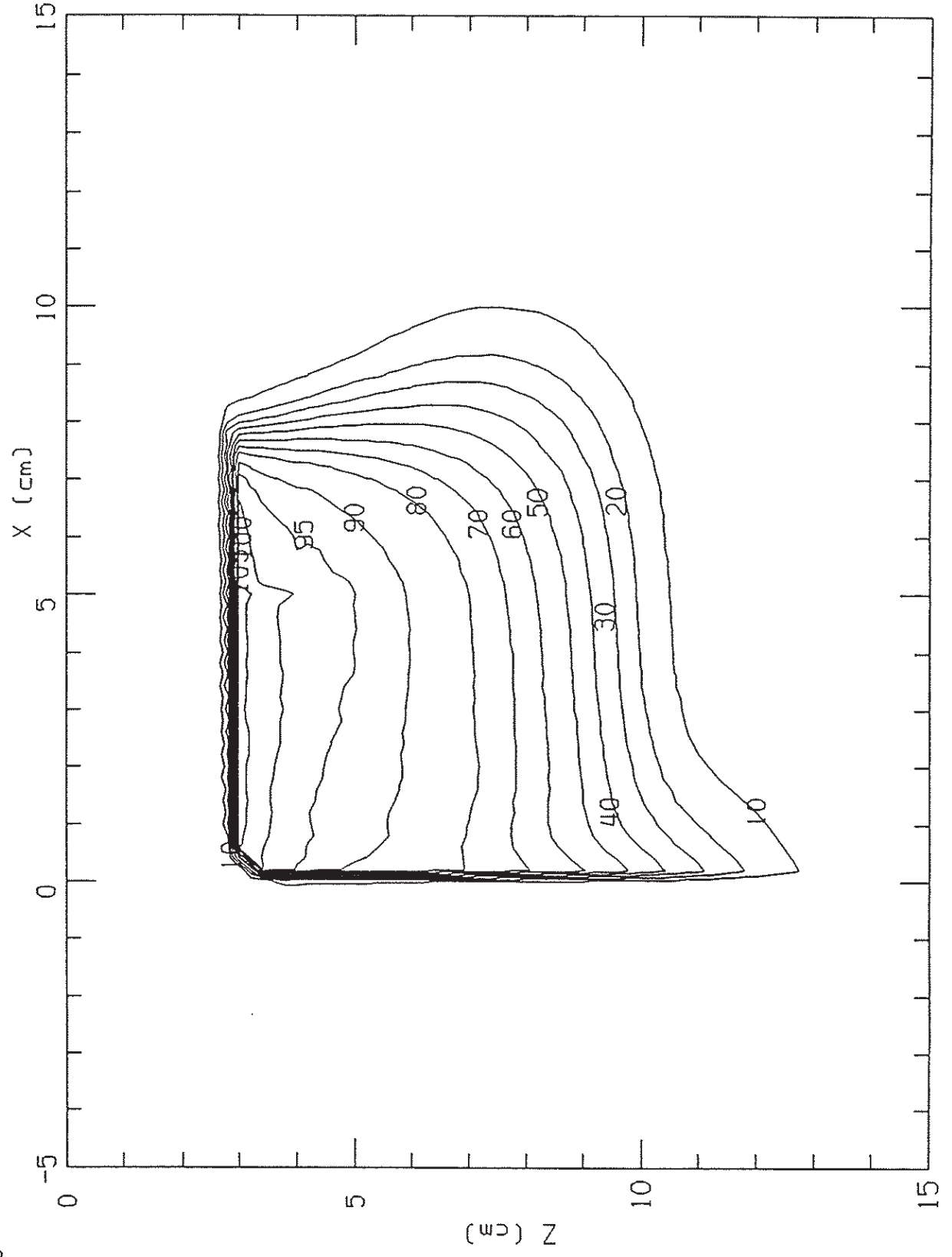

C232DM09B0NY0000.OUT

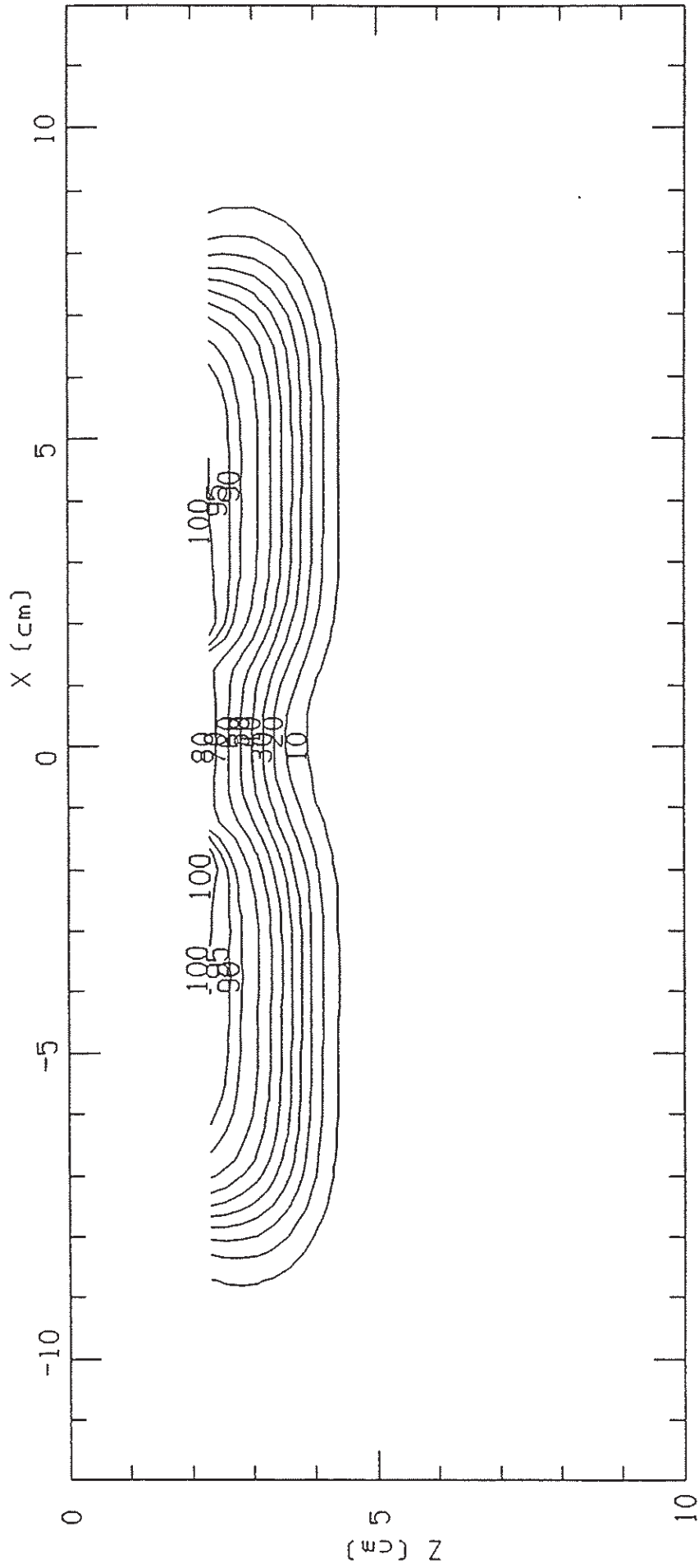

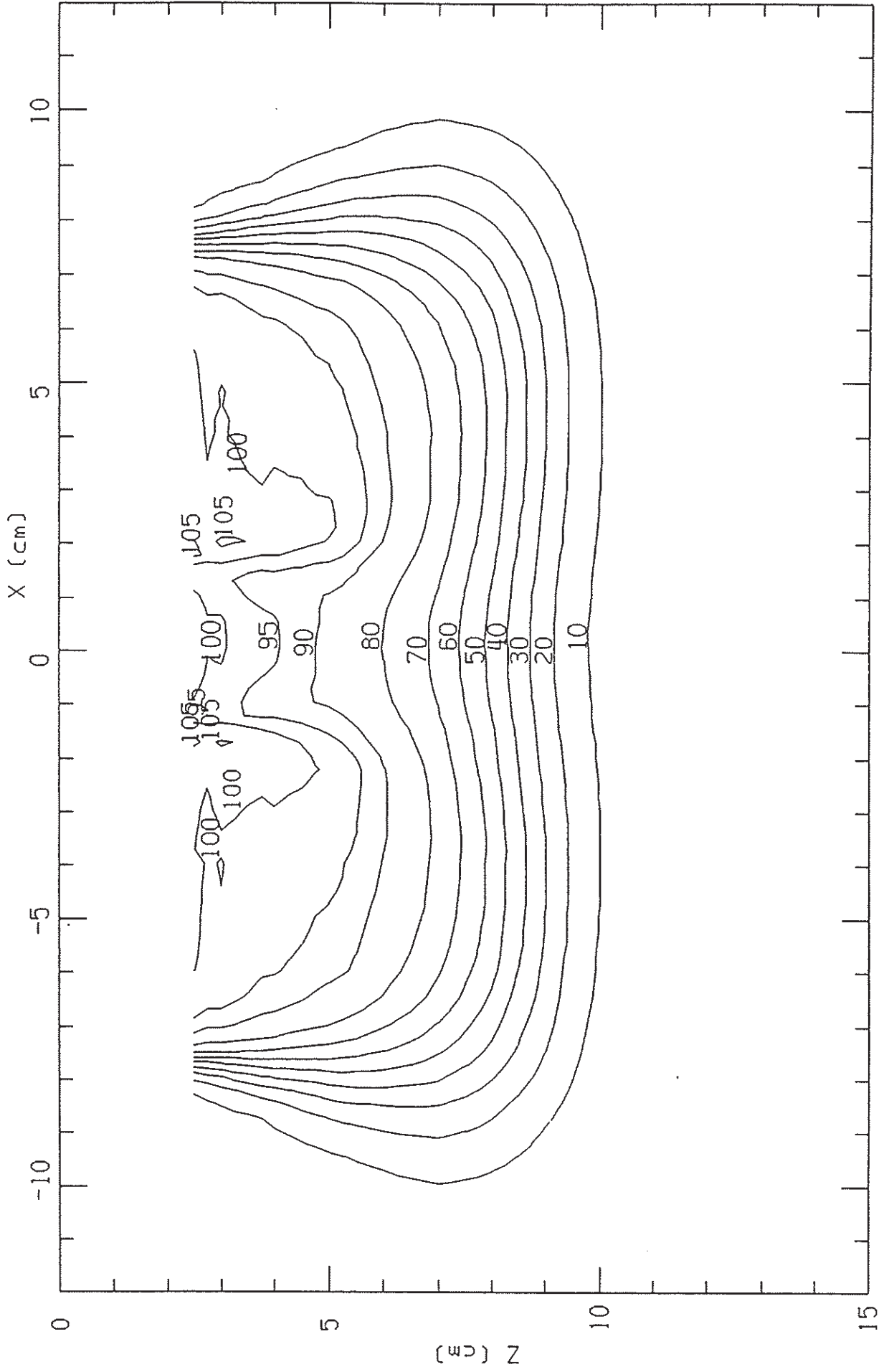

C252DM09AIRY0000.OUT

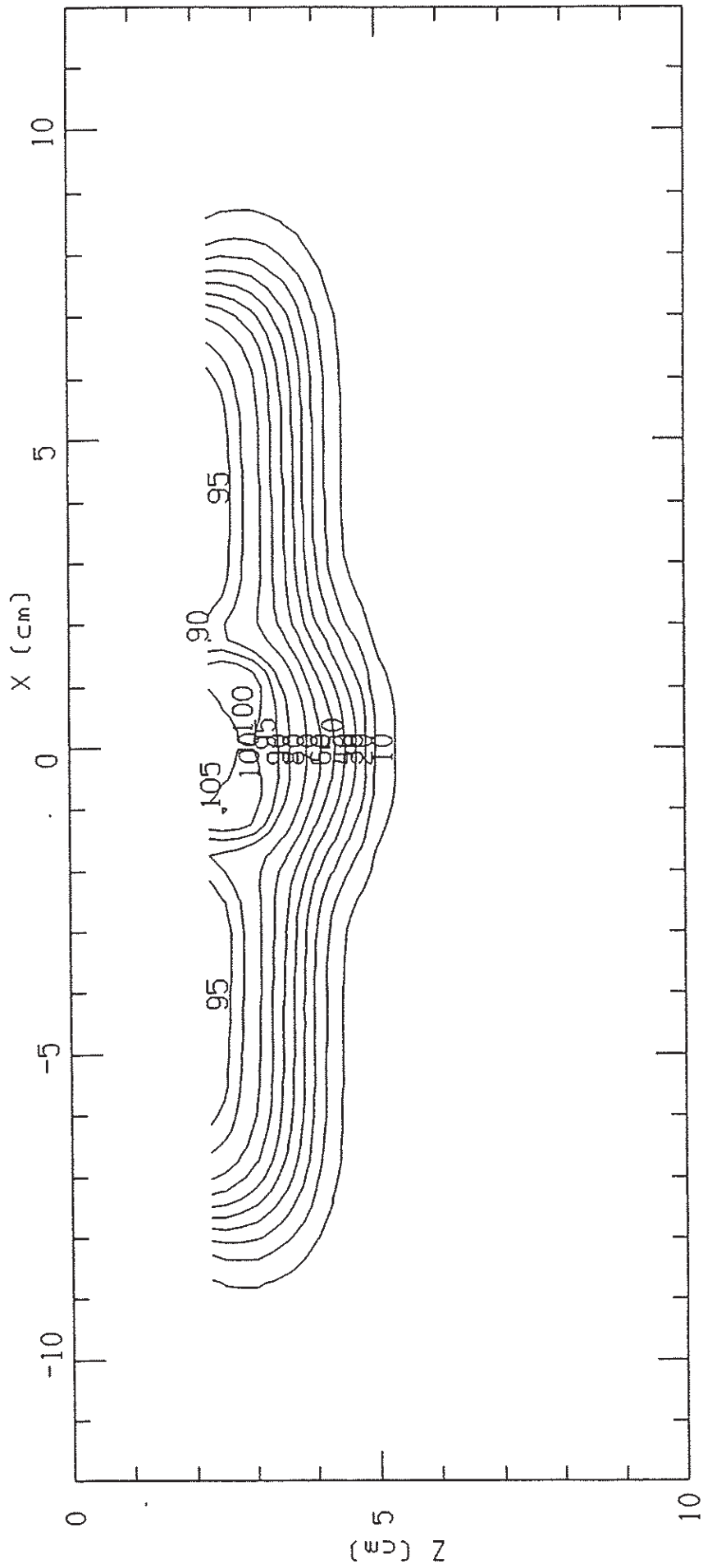

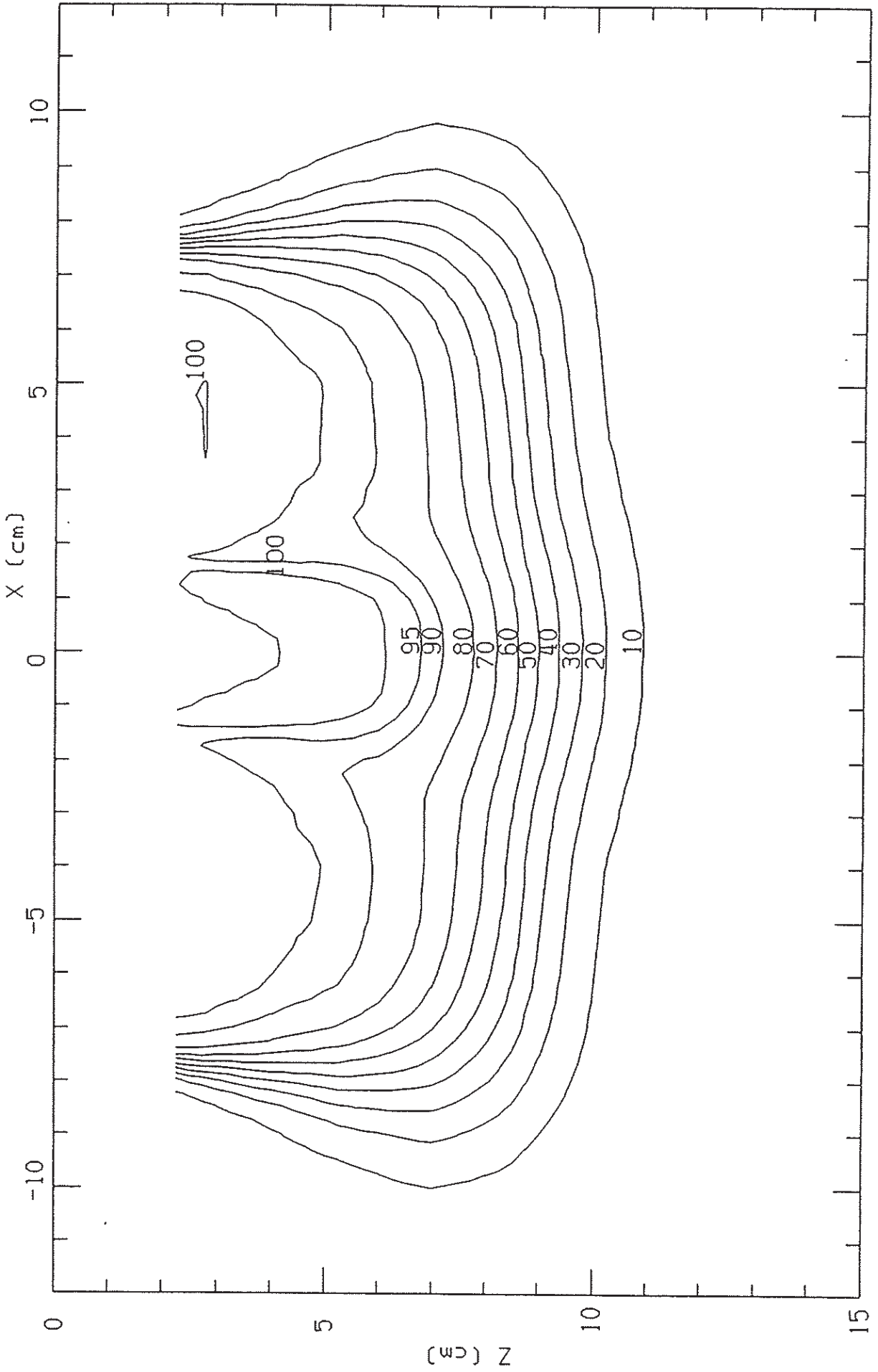

\* 8863

C272DM093DIY0010\_MOD.OUT

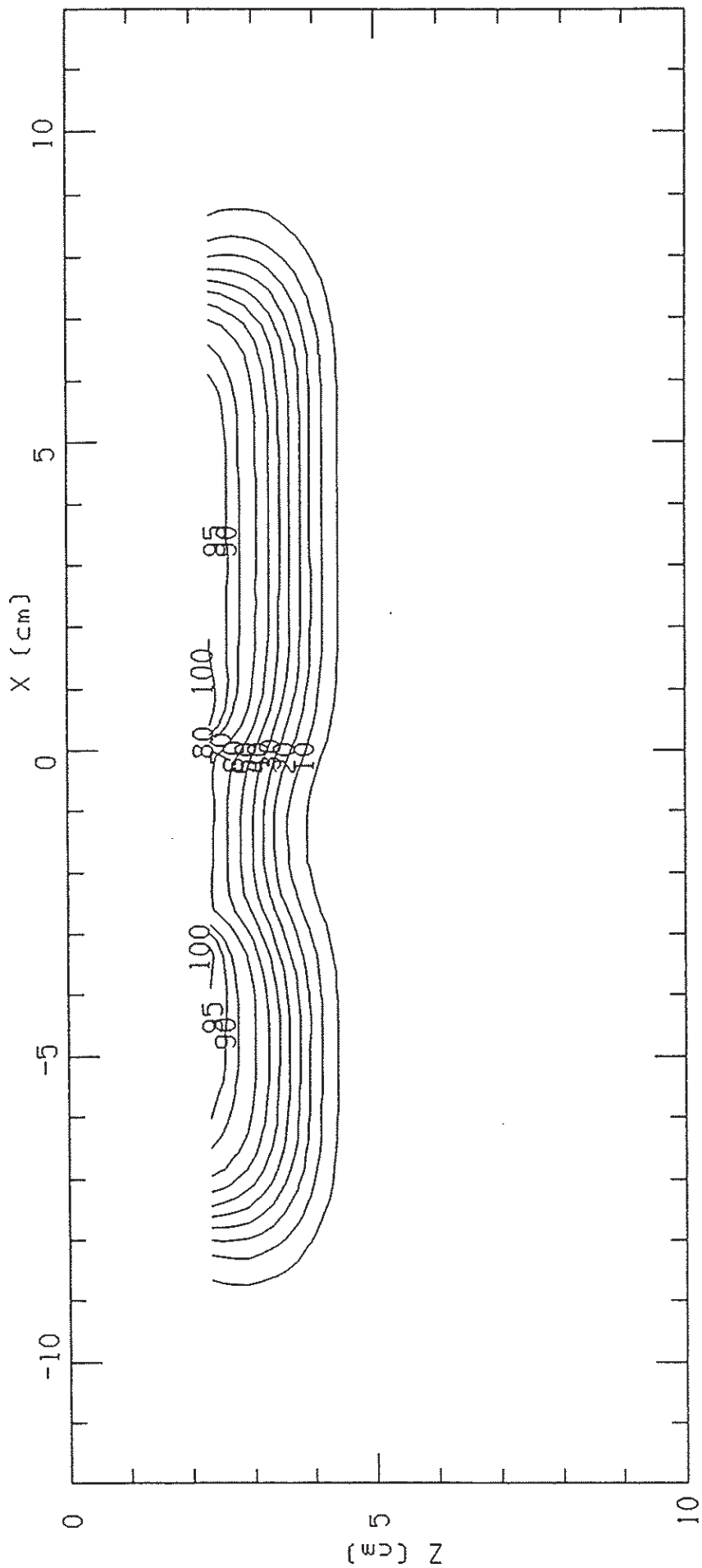

C272DM093DIY\_010\_MOD.OUT

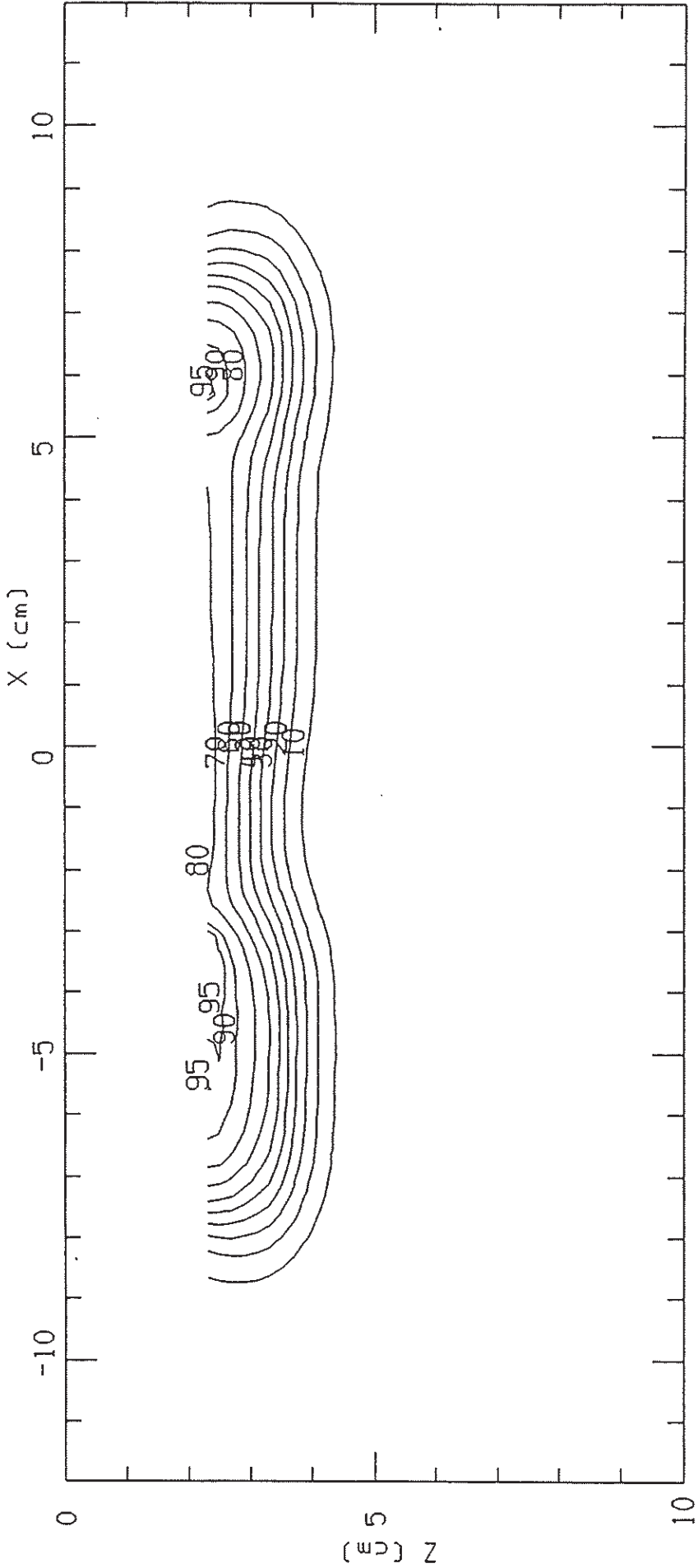

C282DM203DIY0010.OUT

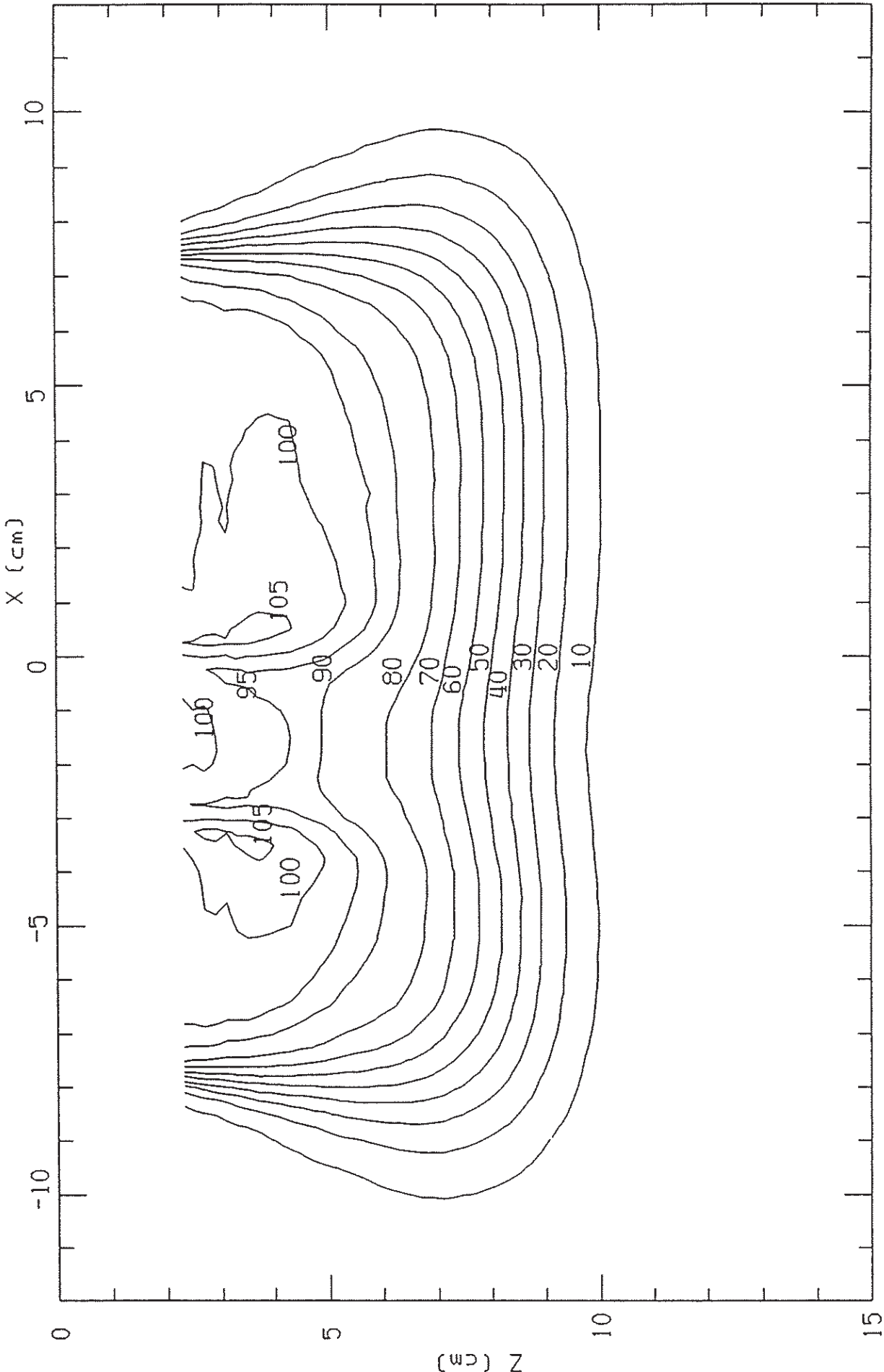

10012007002.001

38G3

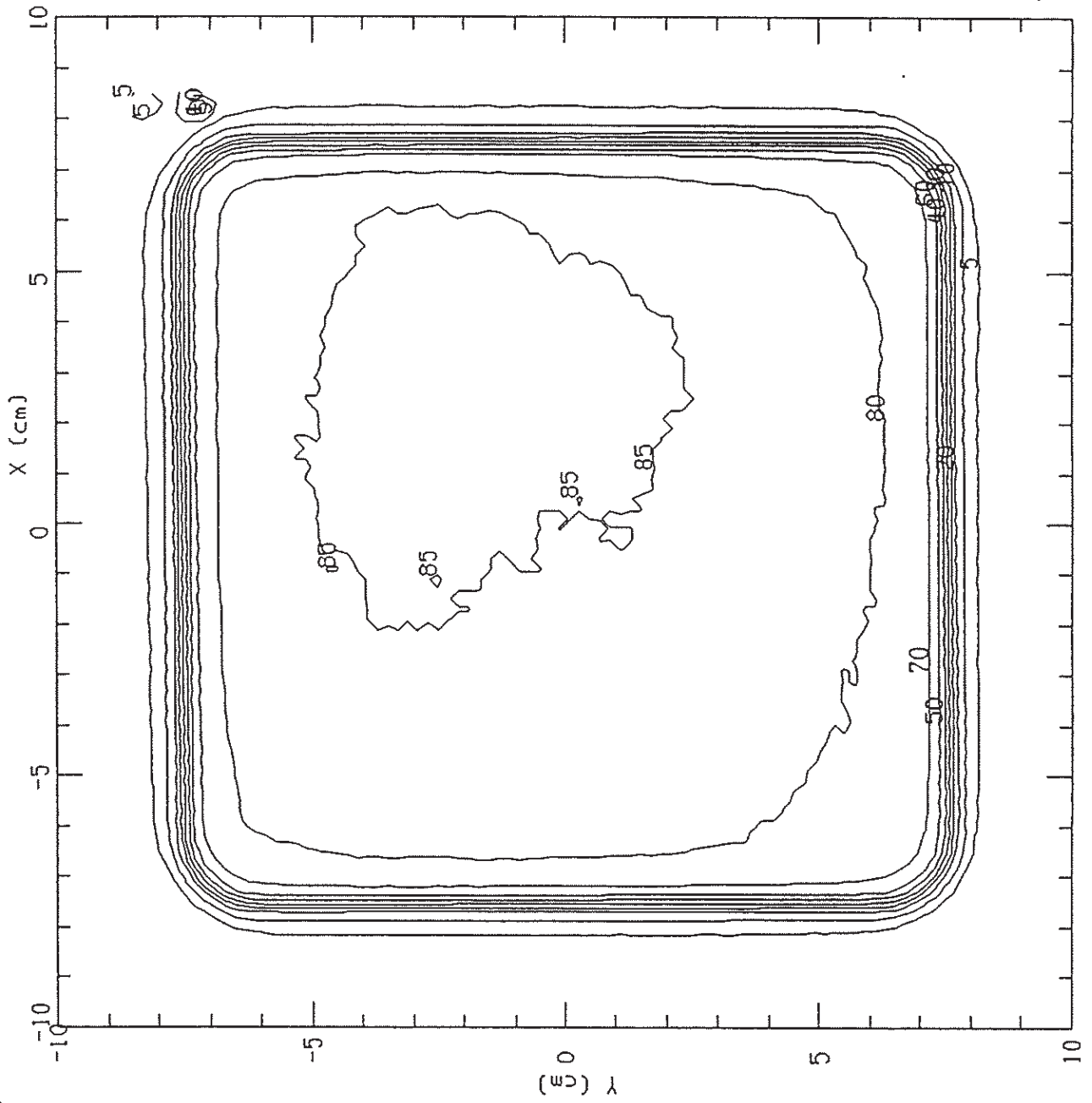

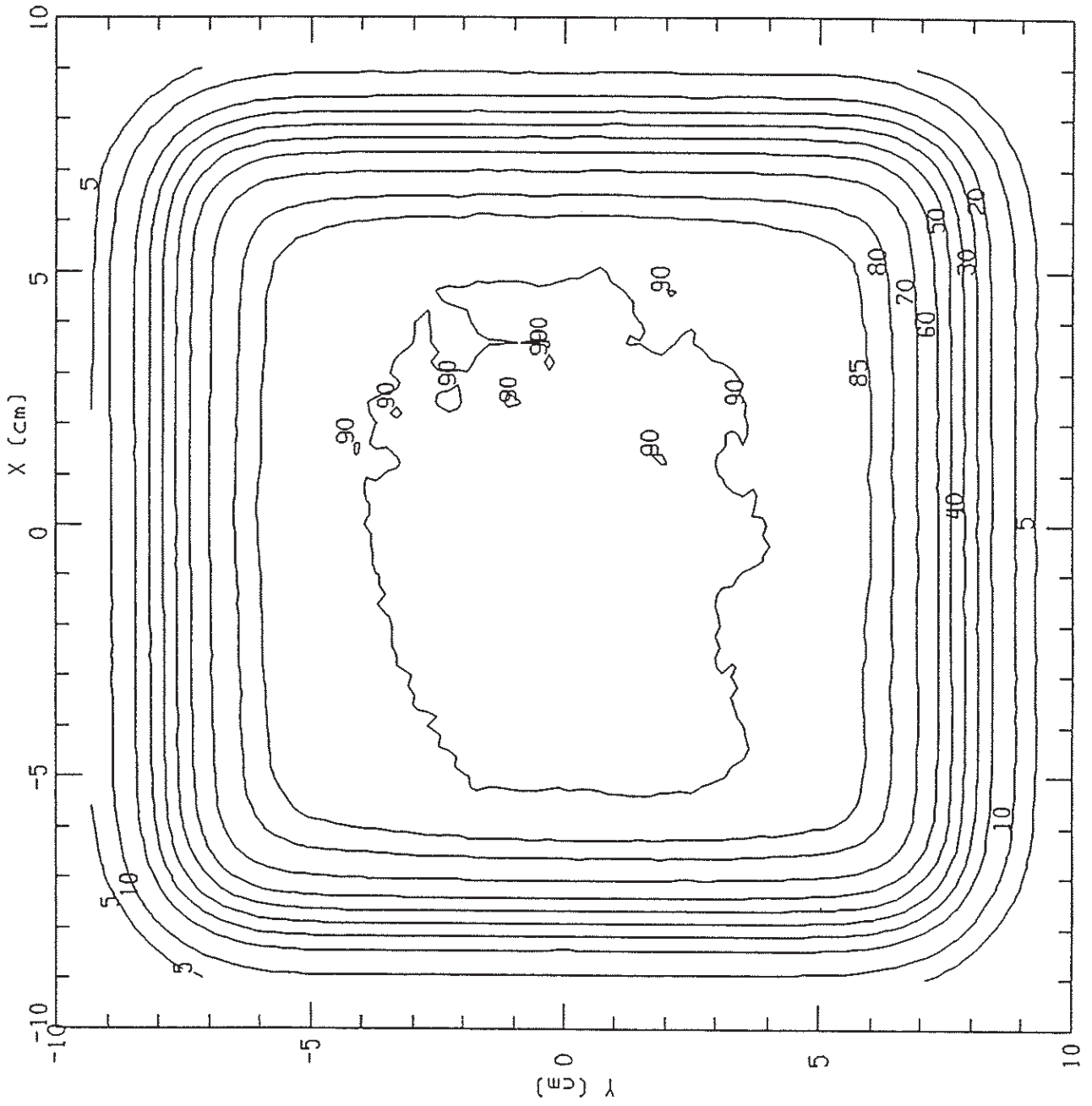

\* 8863

C02BEV09060Z002.OUT

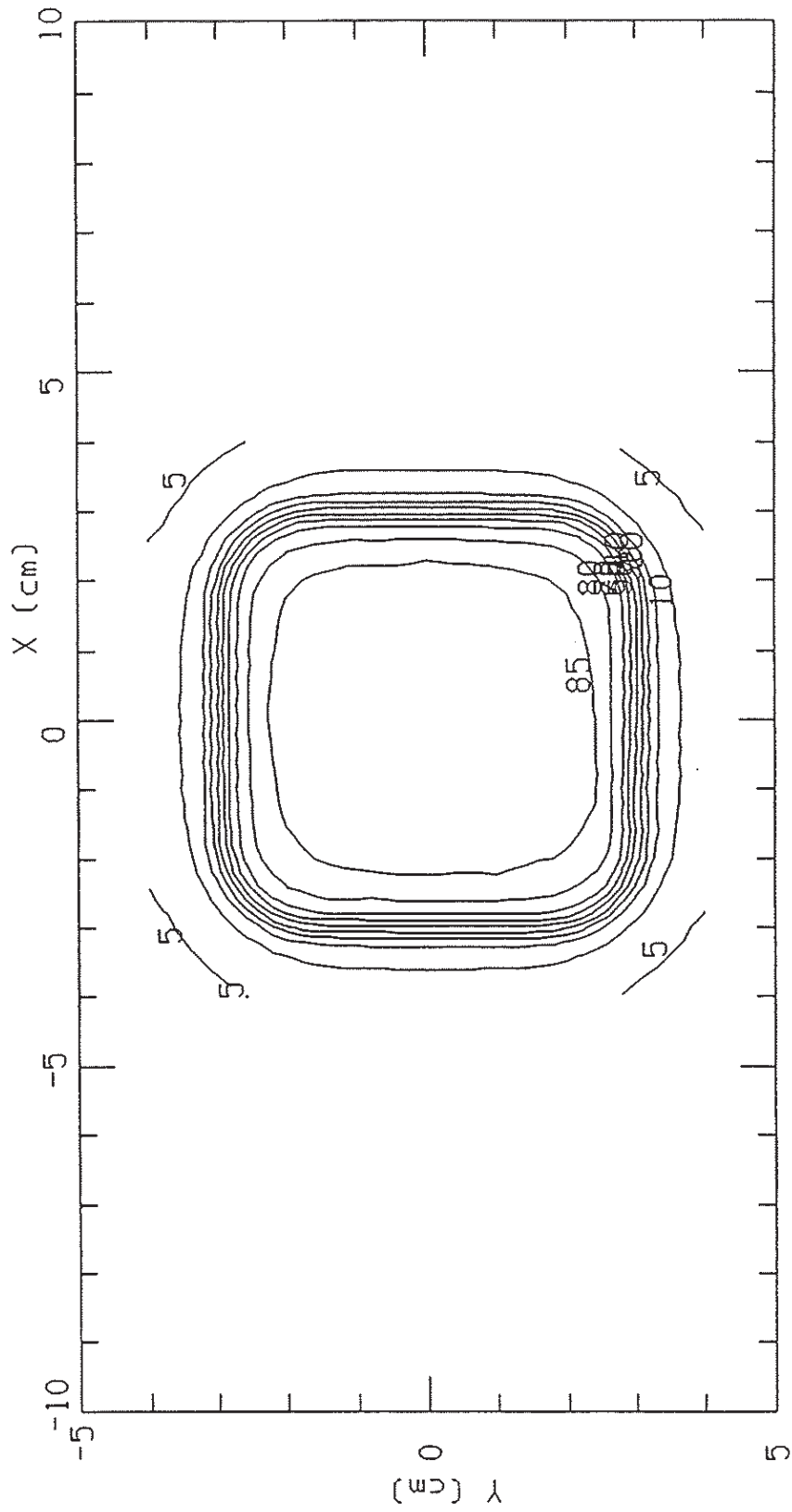

C028EV09060Z026.DUT

8863

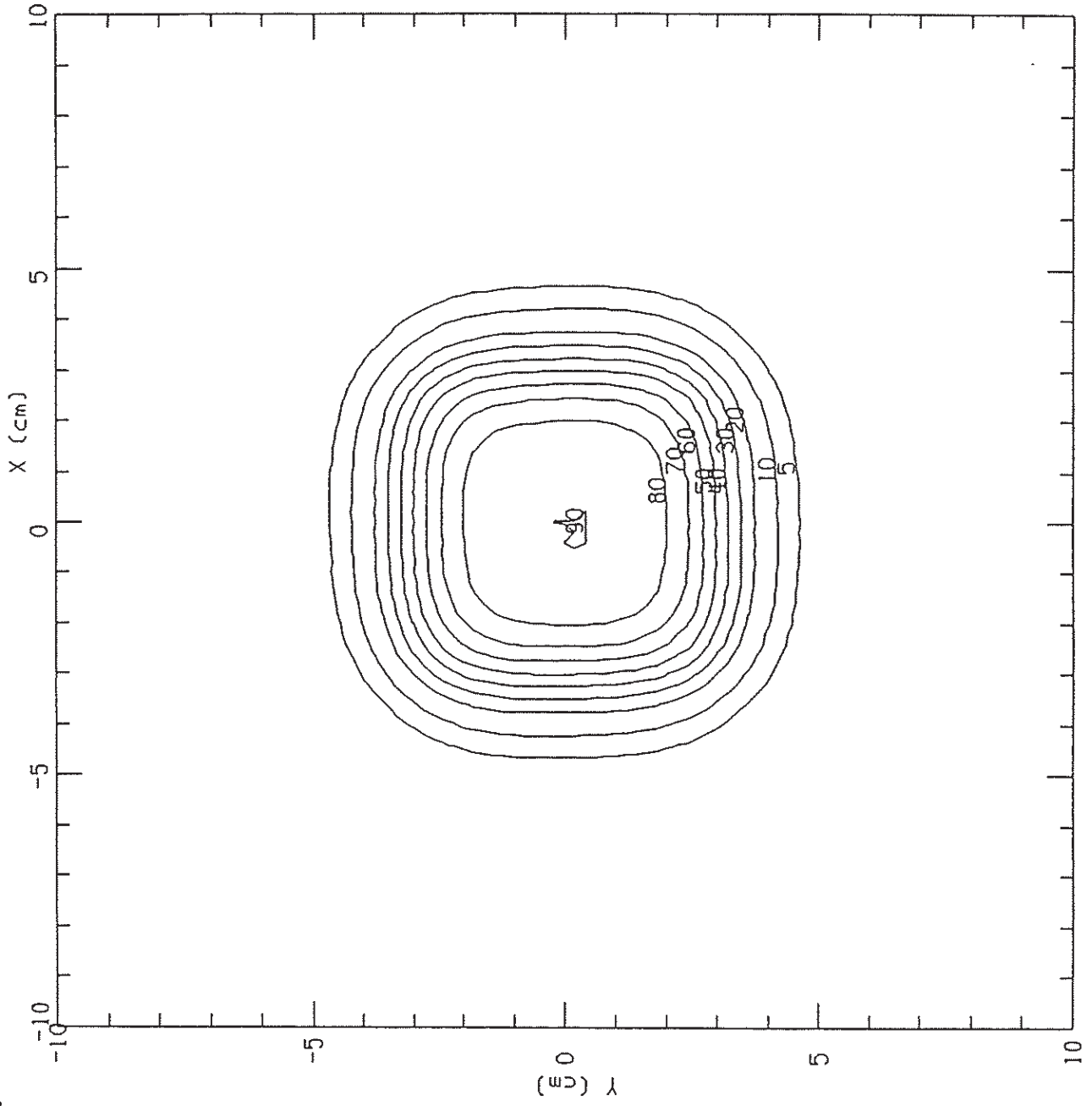

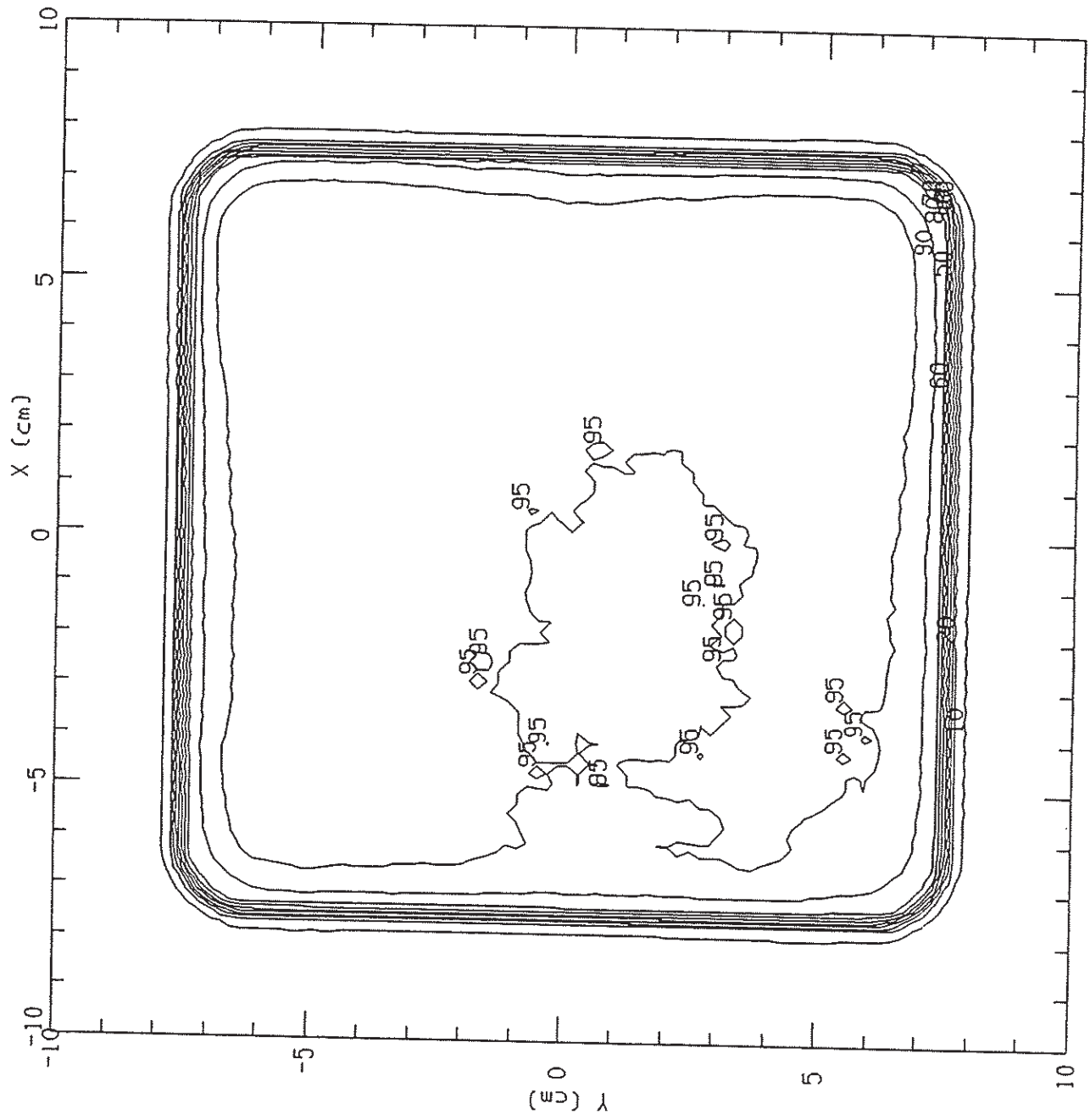

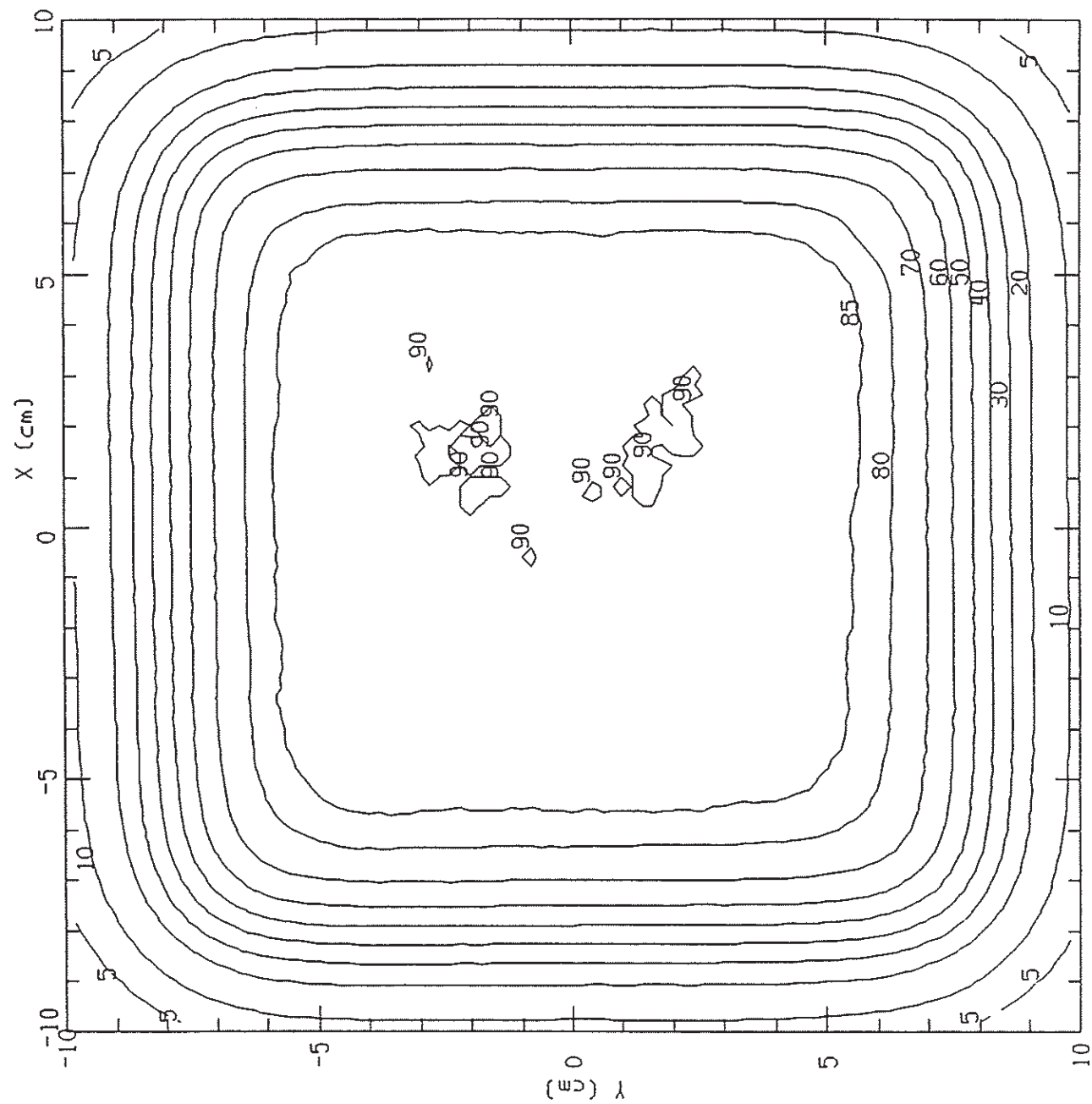

\* 8863 \*

C04BEV20060Z002\_MOD.OUT

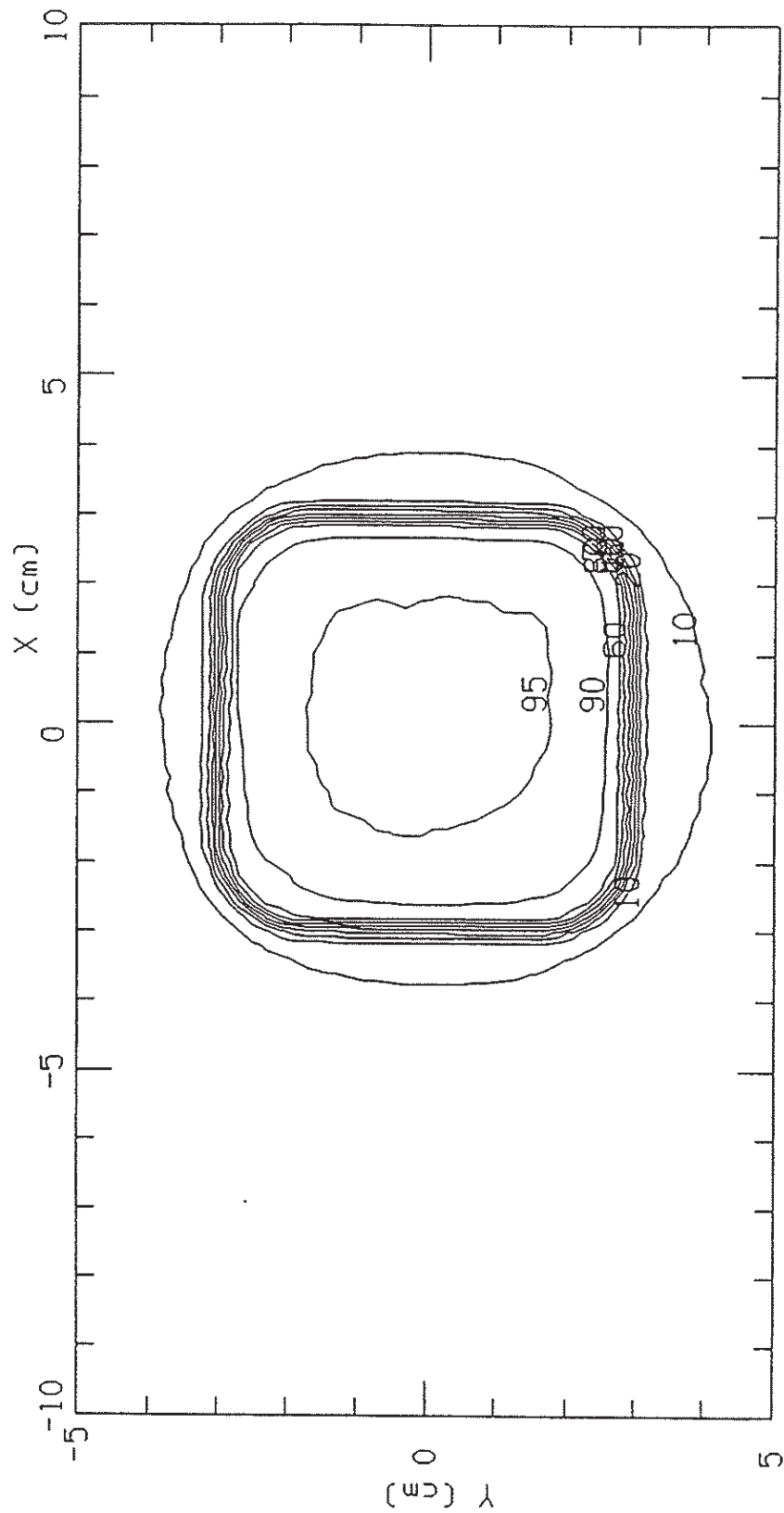

C04BEV20060Z047\_MOD.OUT

8863

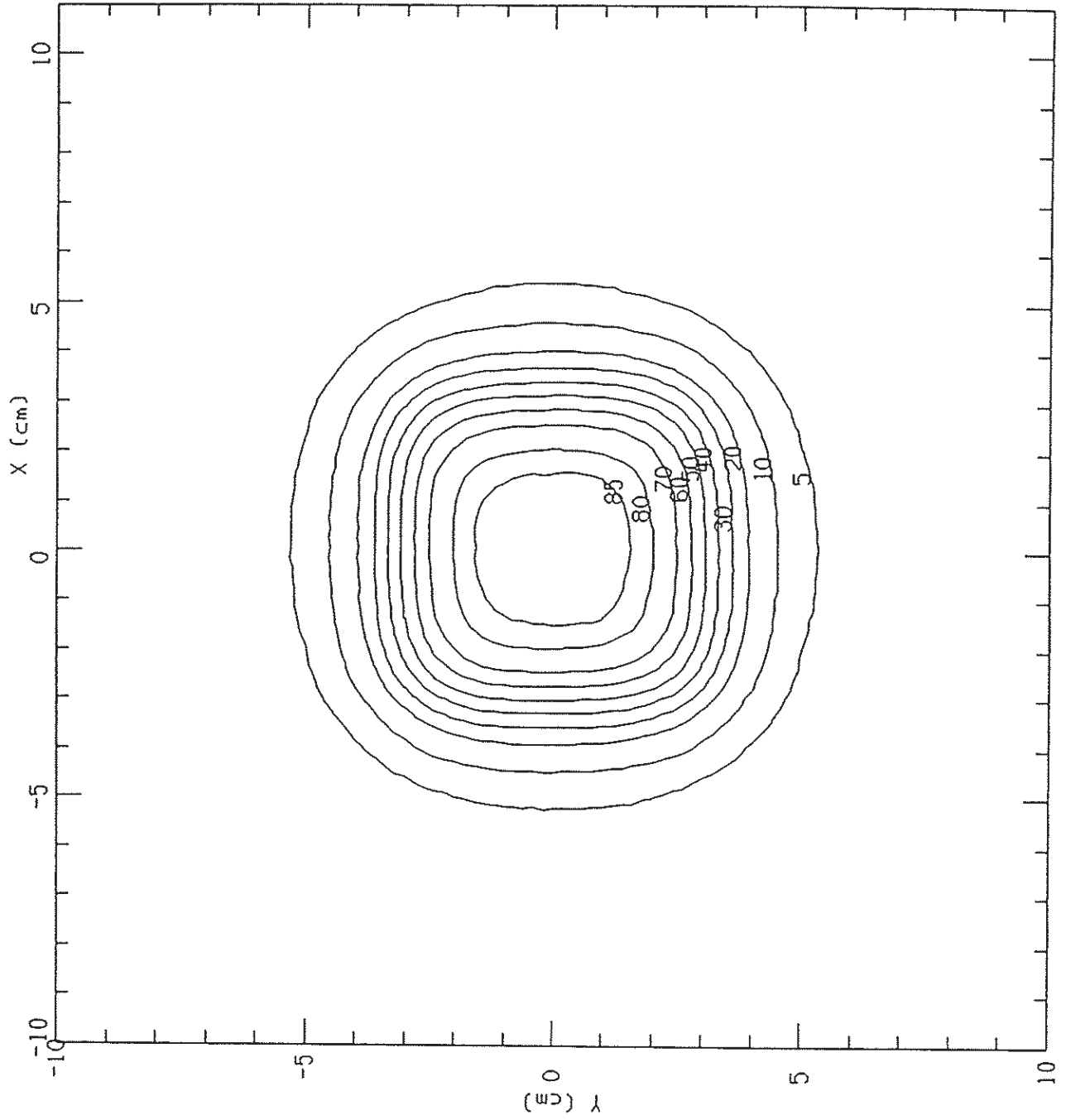

\* 8863

C058EV09150Z002\_MOD.OUT

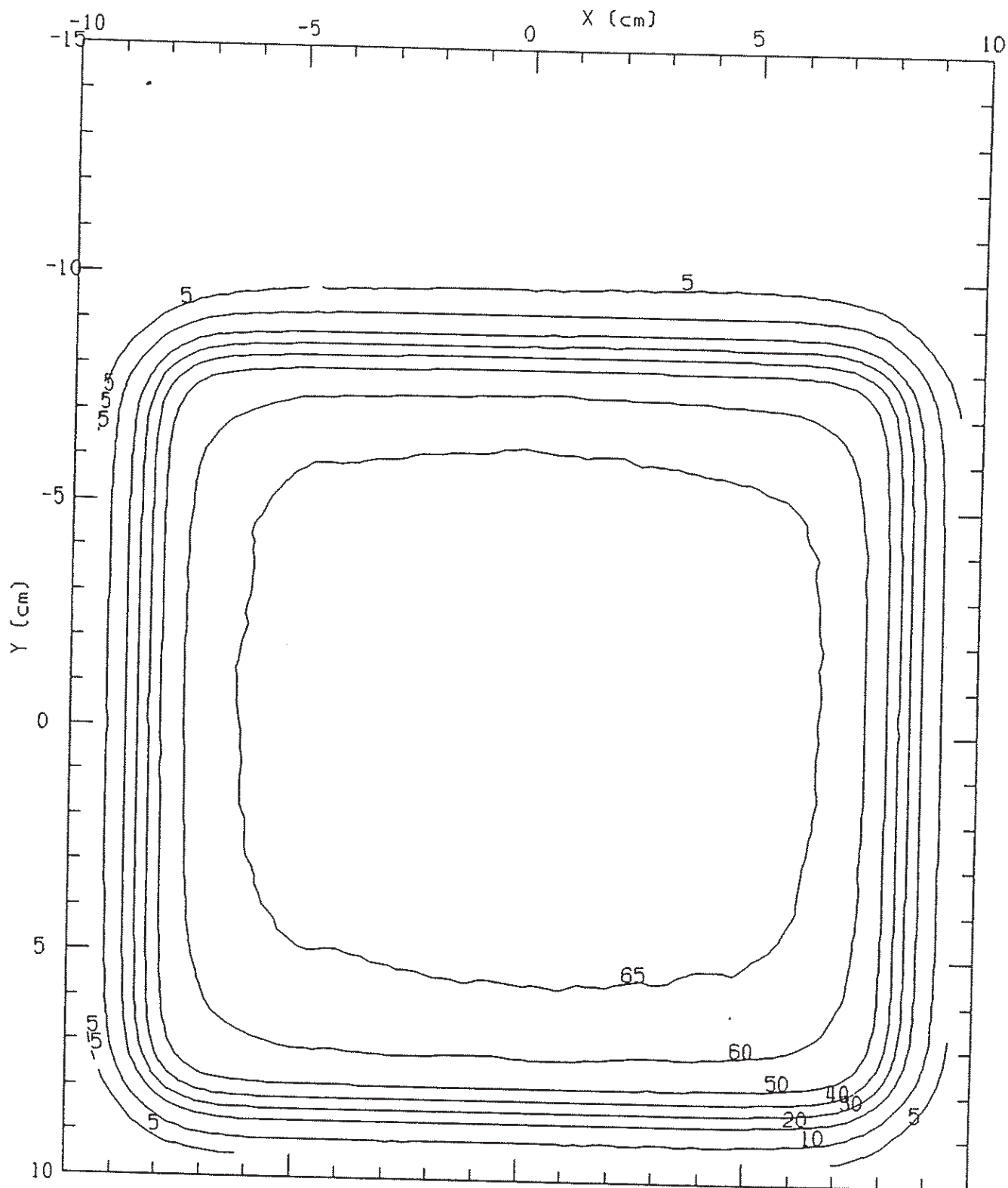

CL1800  
c05bev09150z028\_modified

15.0, 15.0

110.0

X (cm)

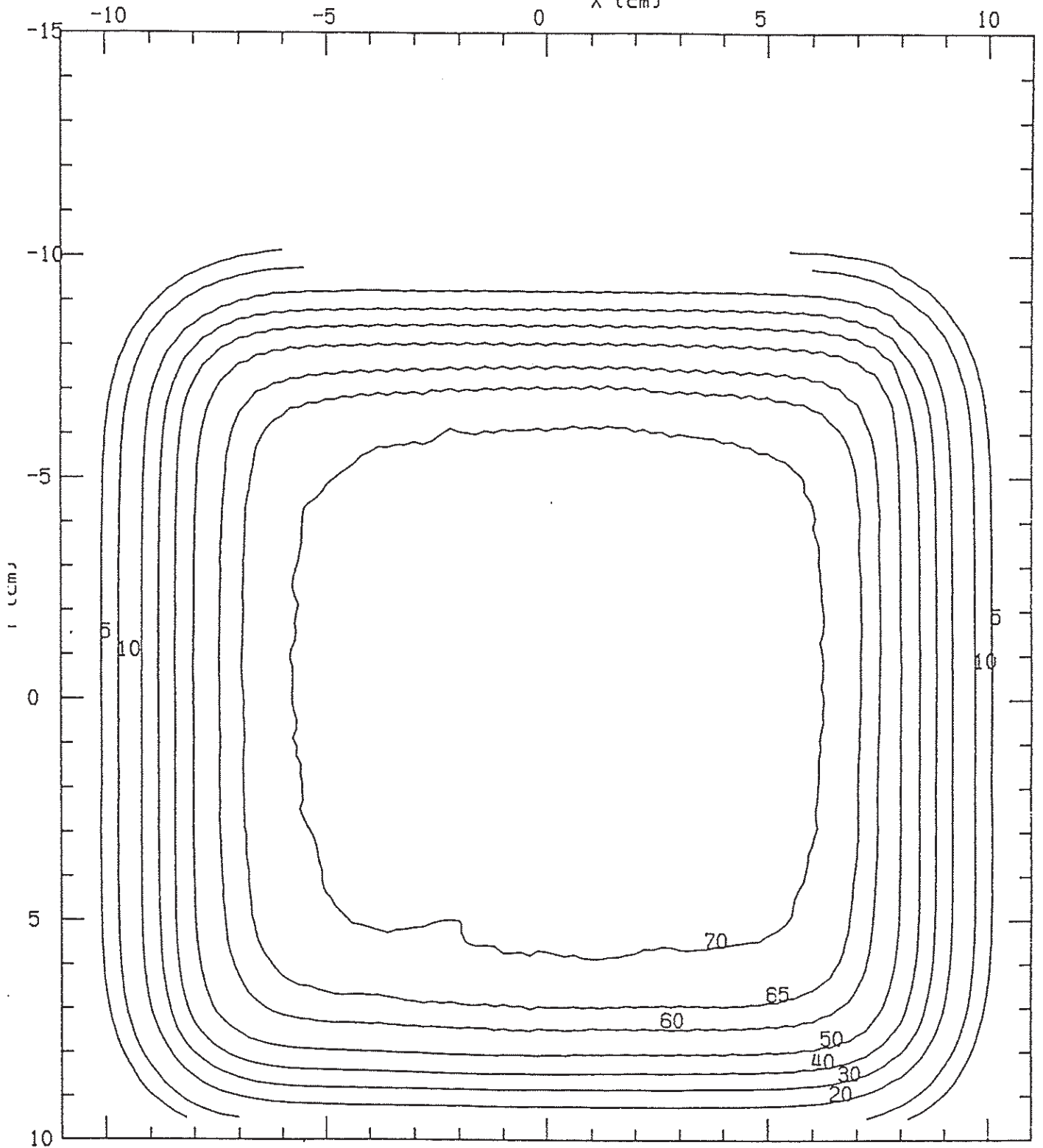

U06BEV09060/002\_MOD.OUT

3863

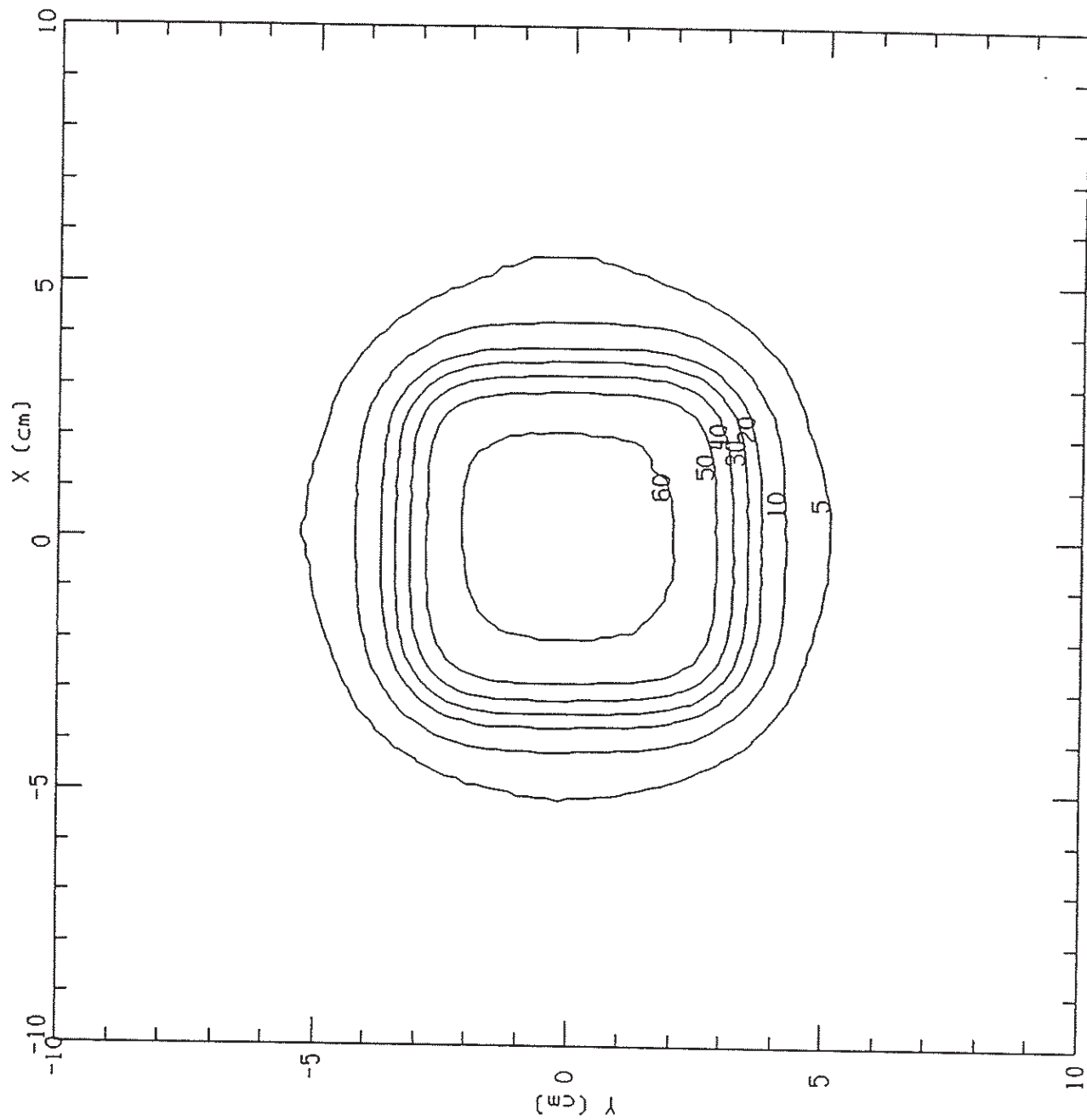

C068EV09060Z027\_MOD. OUT

88G3

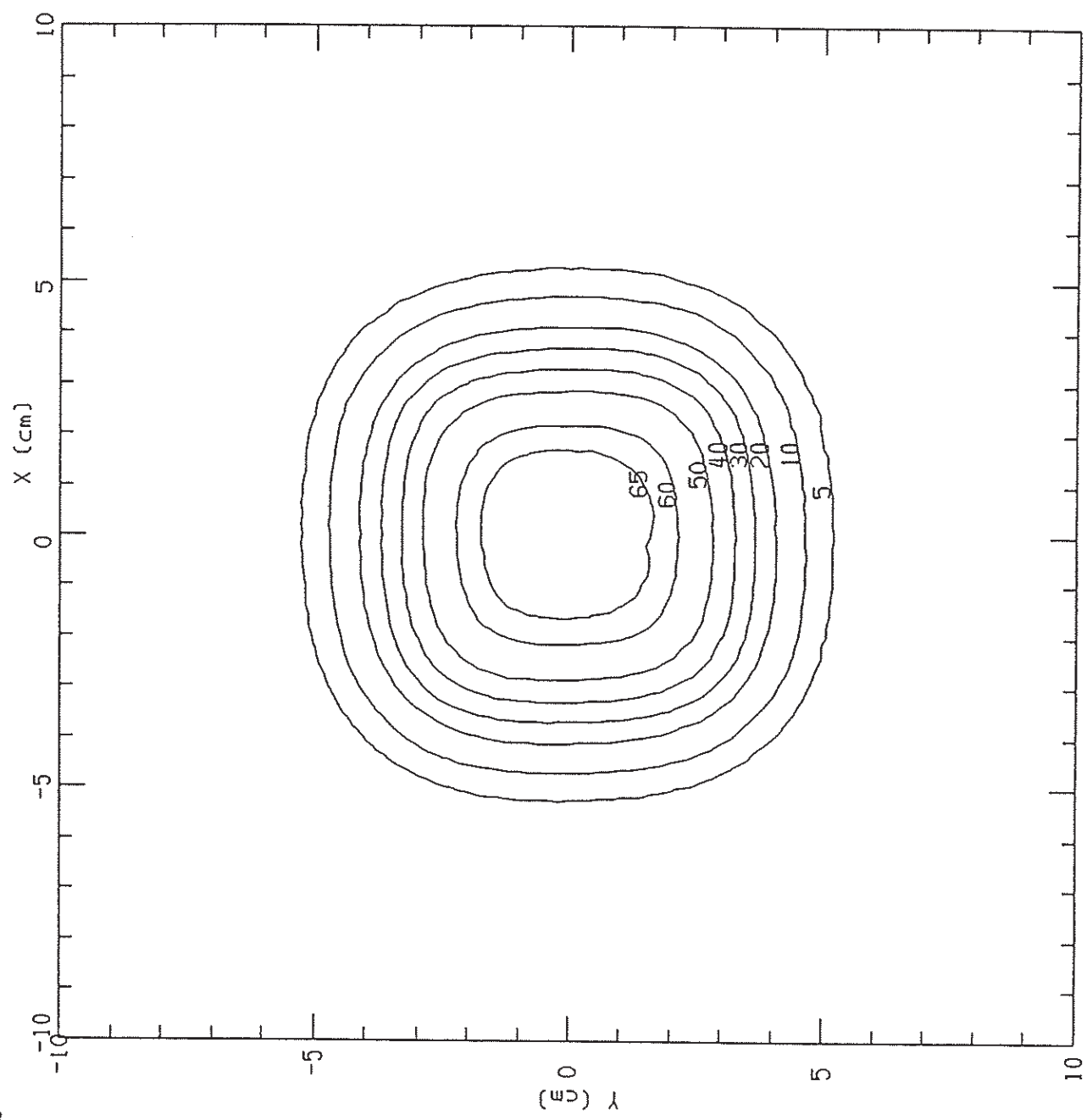

C07BEV20150Z002\_M00.OUT

8863

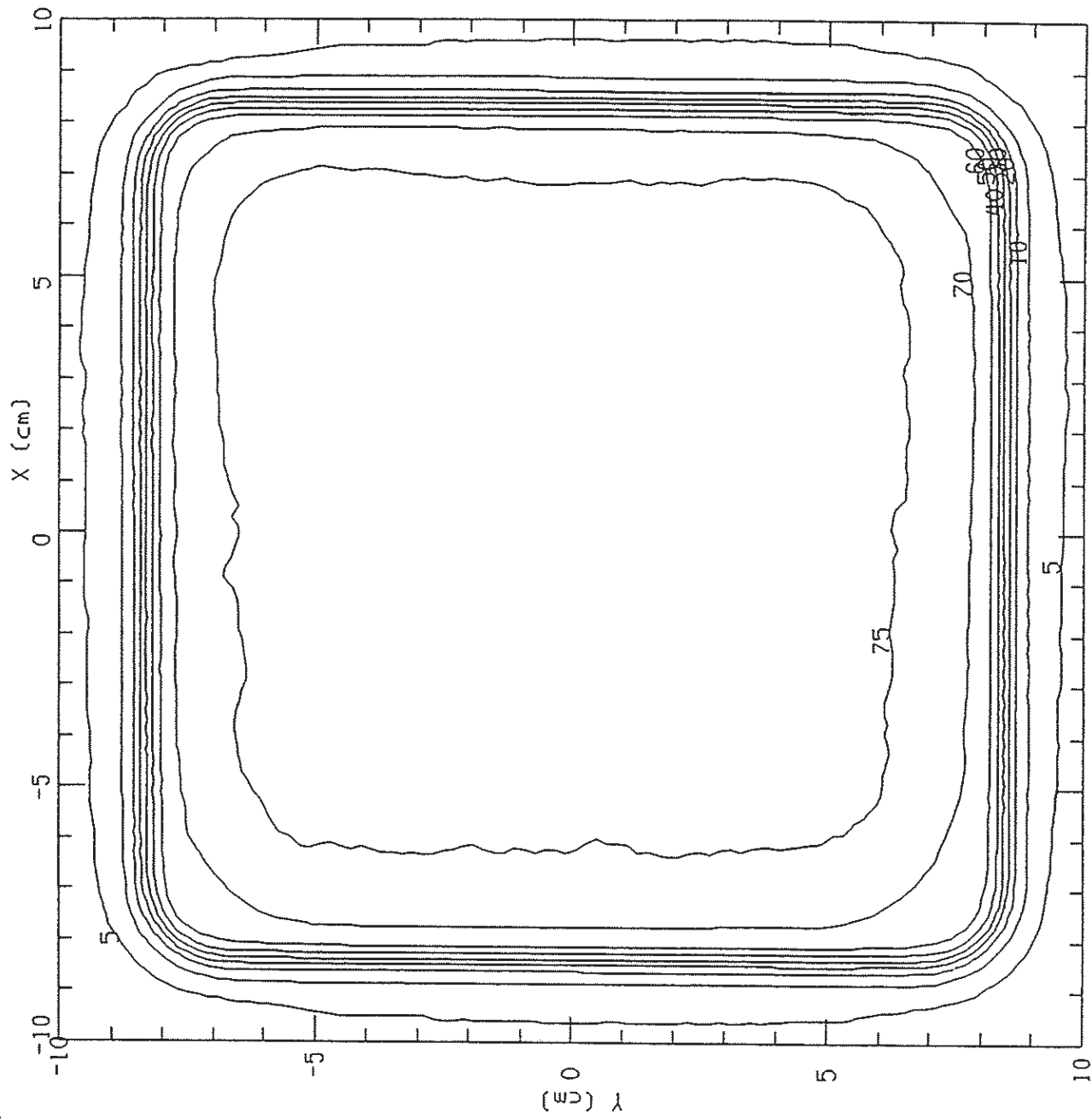

CL1800

c07bev20150z061\_mod

110.0

15.0 15.0

X (cm)

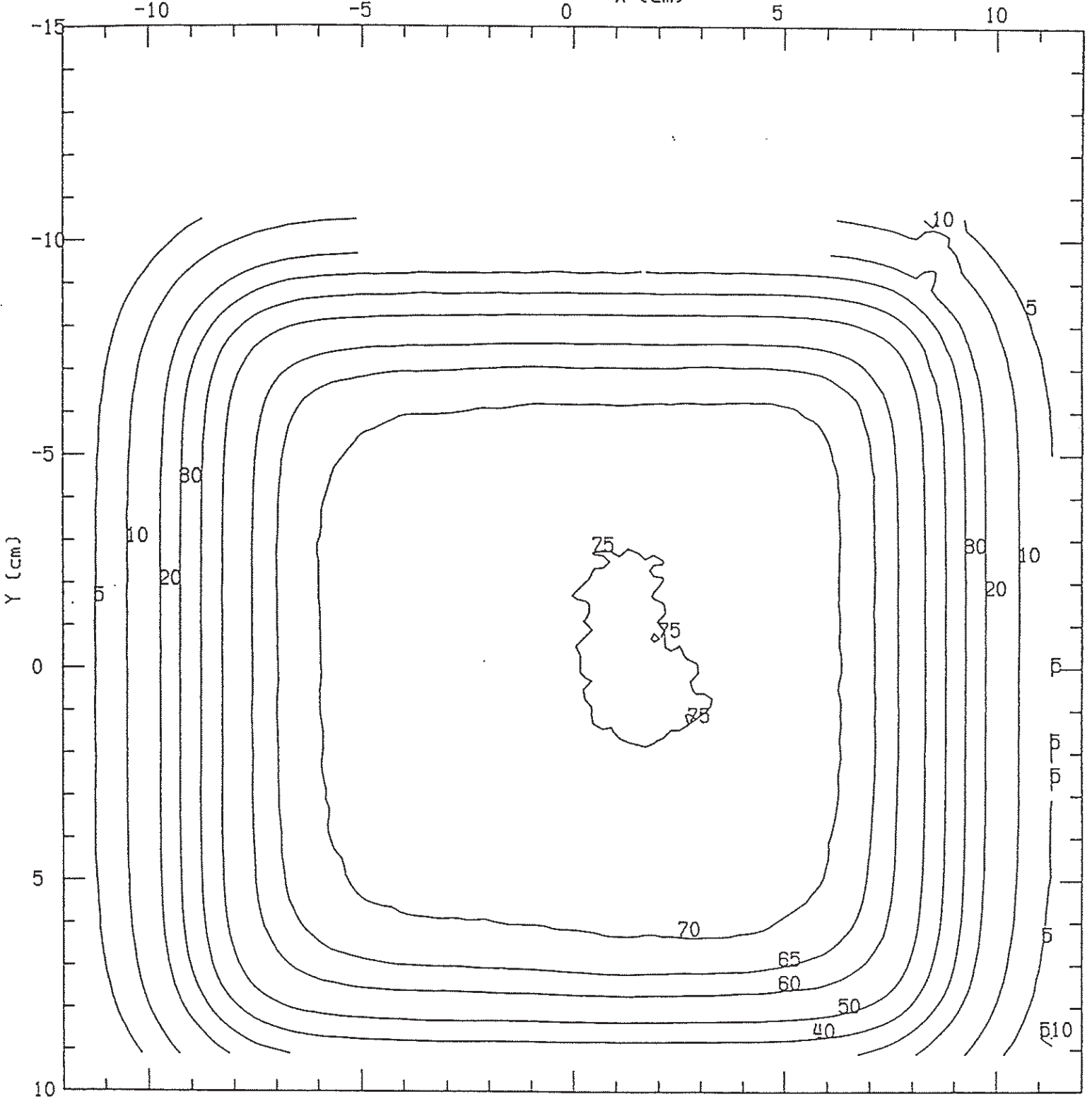

CL1800

C08BEV20060Z002\_MOD

110.0

6.0. 6.0

X (cm)

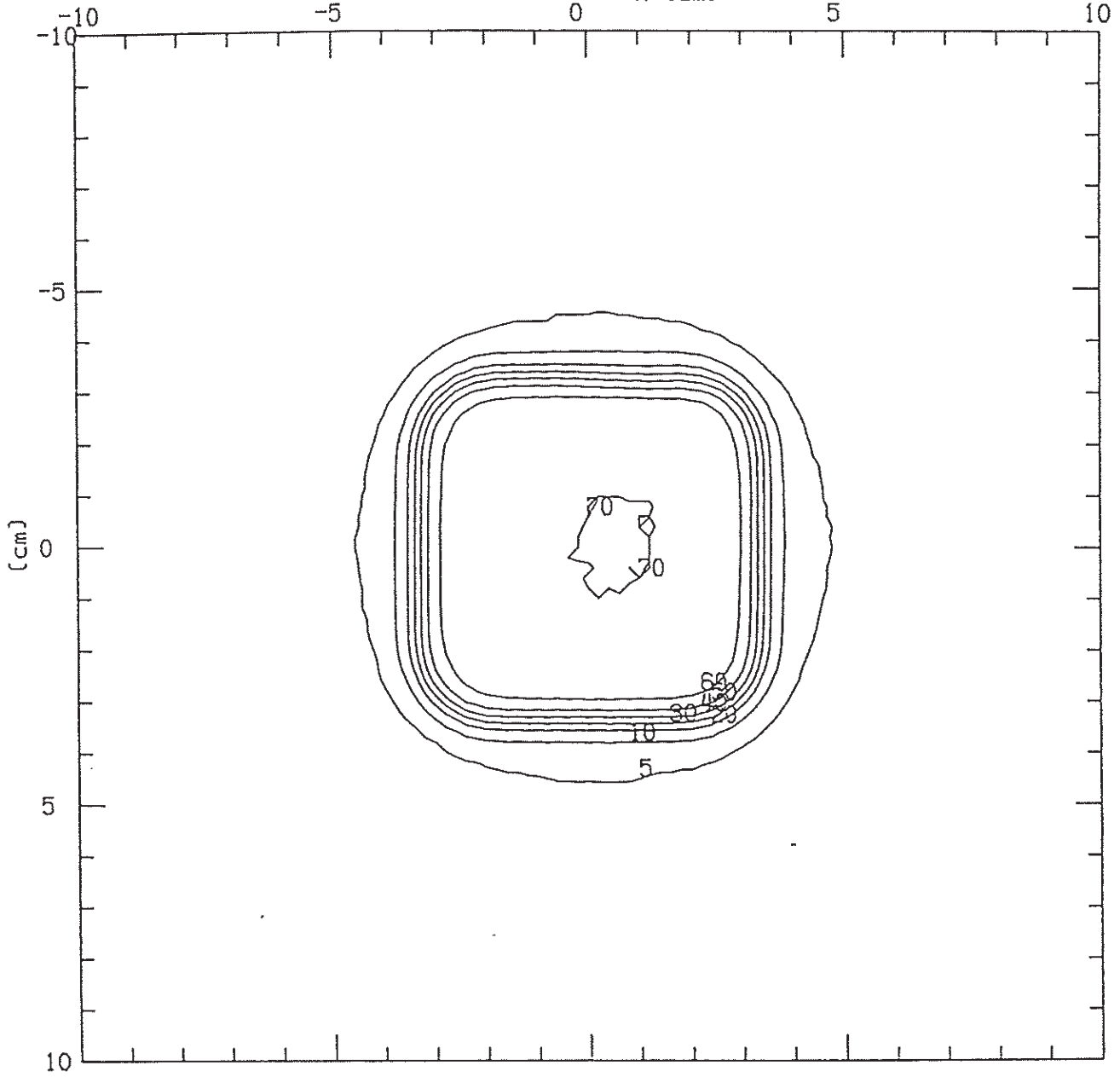

C08BEV20060Z055\_MOD

CL1800

110.0

6.0 6.0  
X (cm)

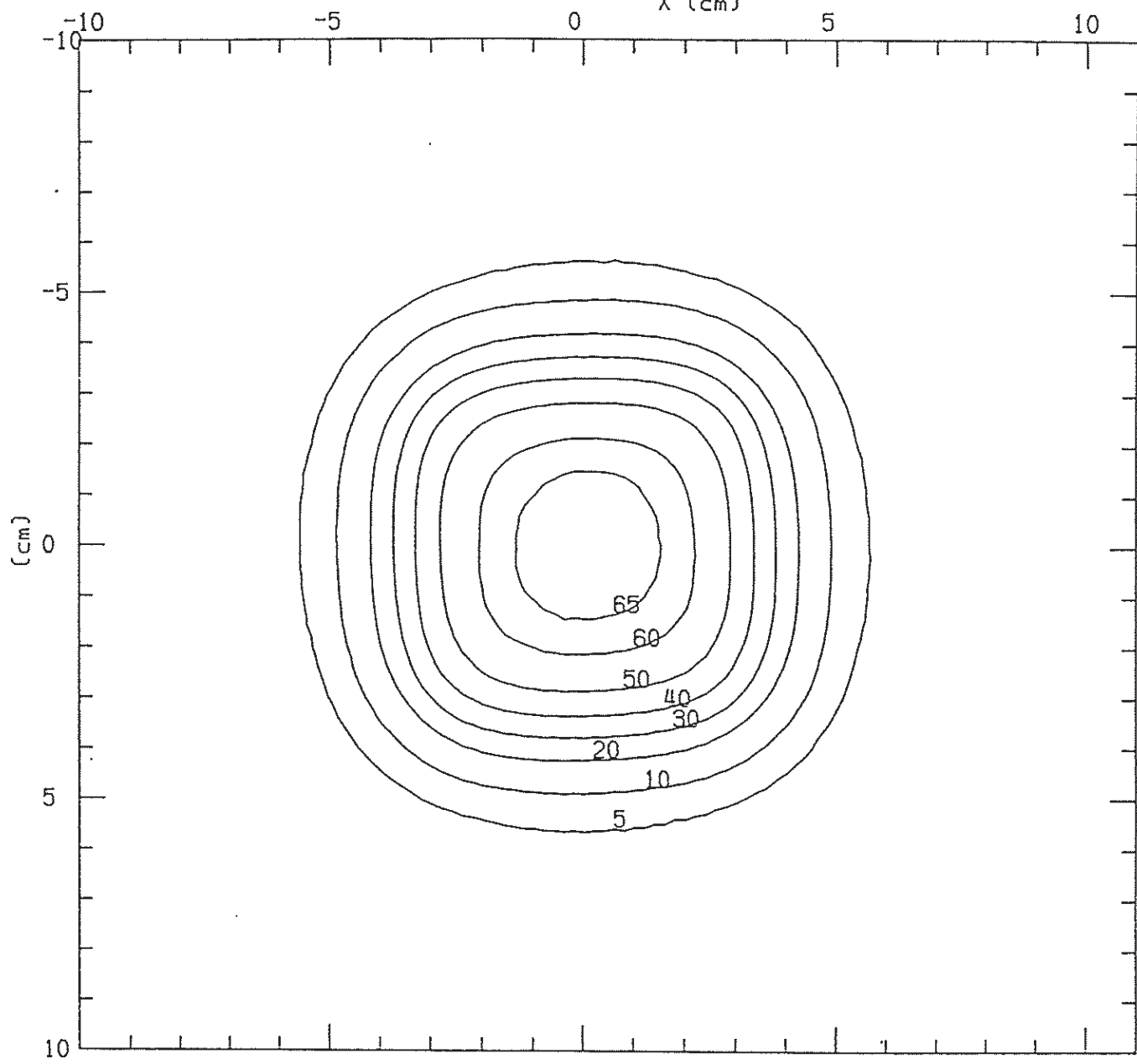

\* 8388 \*

CL 1800

c09bev09recz002\_mod

100.0

15.0, 15.0

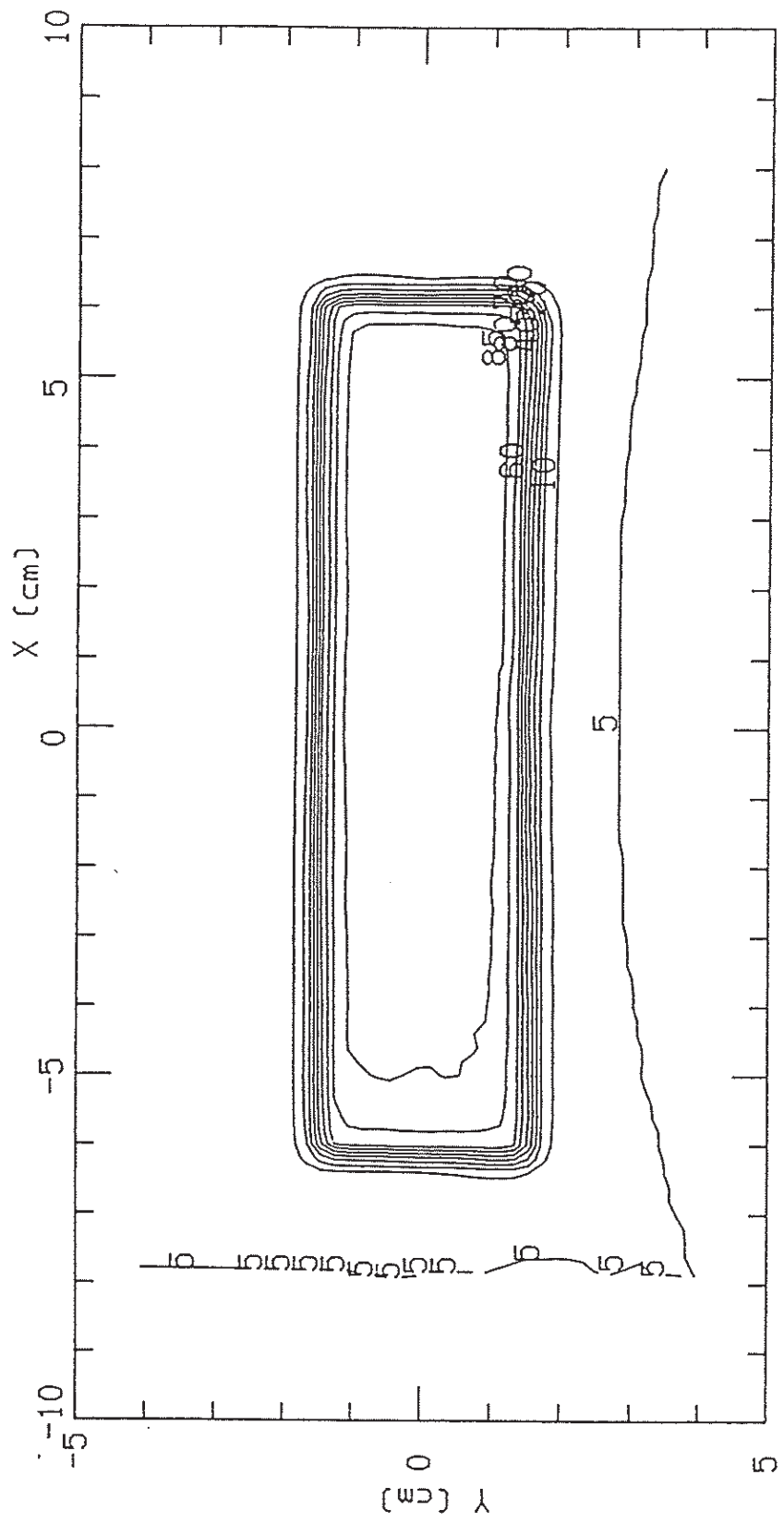

\* 8863

CL 1800

c09bev09recz028\_mod

100.0

15.0, 15.0

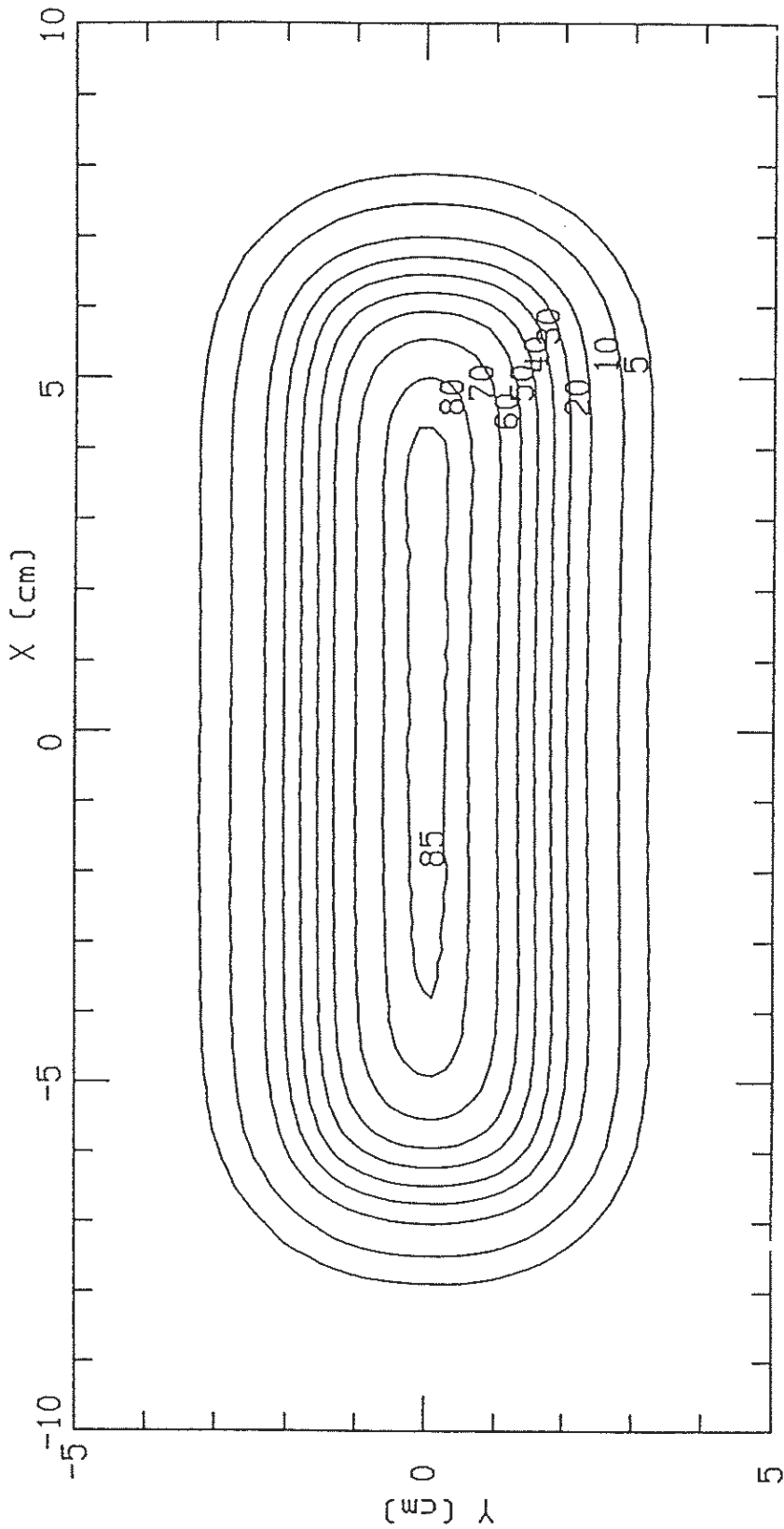

\* 8863 \*

c10bev20recz002

CL 1800

100.0

15.0, 15.0

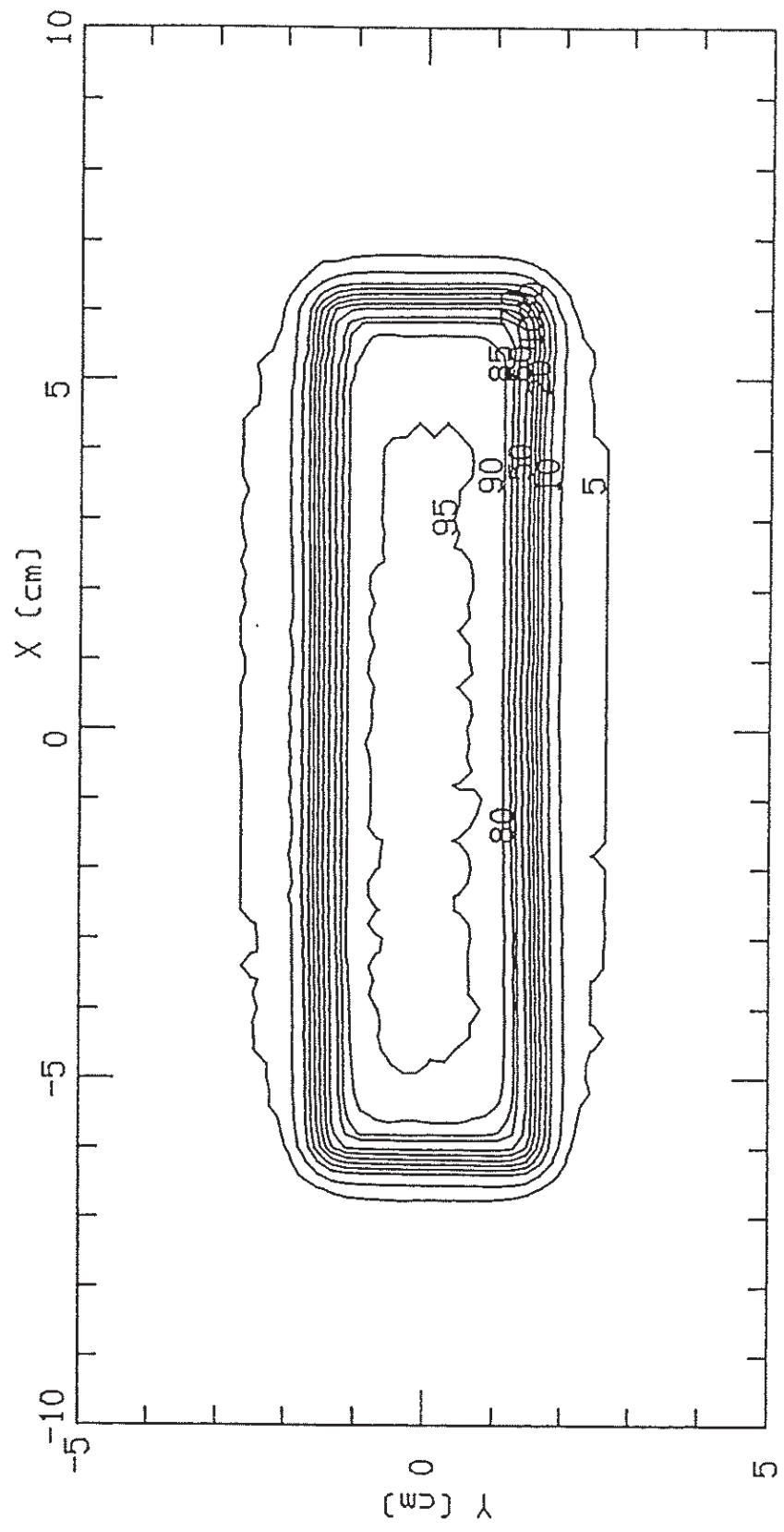

\* 8863

CL-1800

c10bev20recz061

15.0, 15.0

100.0

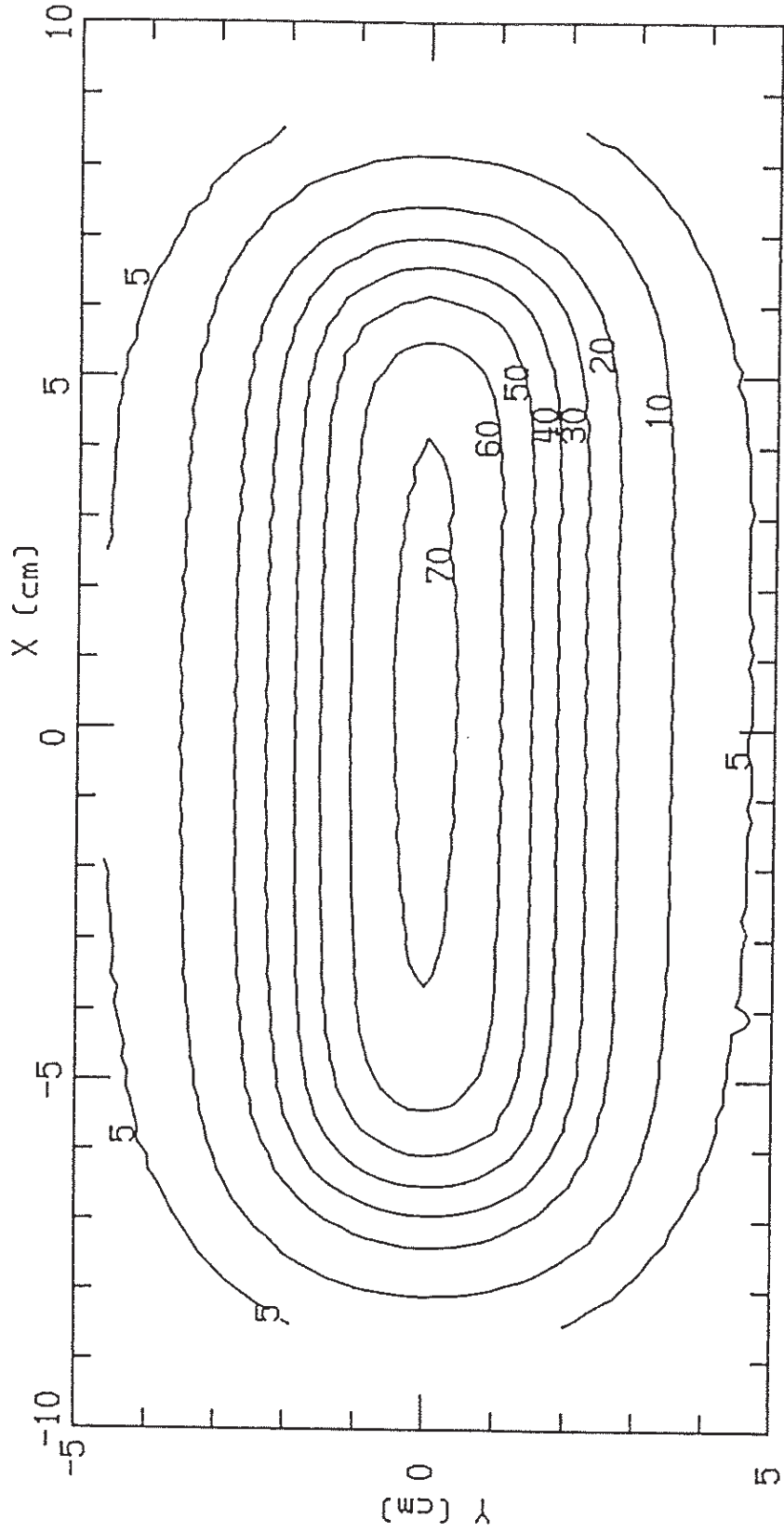

\* 8863

C11BEV09IRRZ028\_MOD CL 1800

15.0, 15.0

100.0

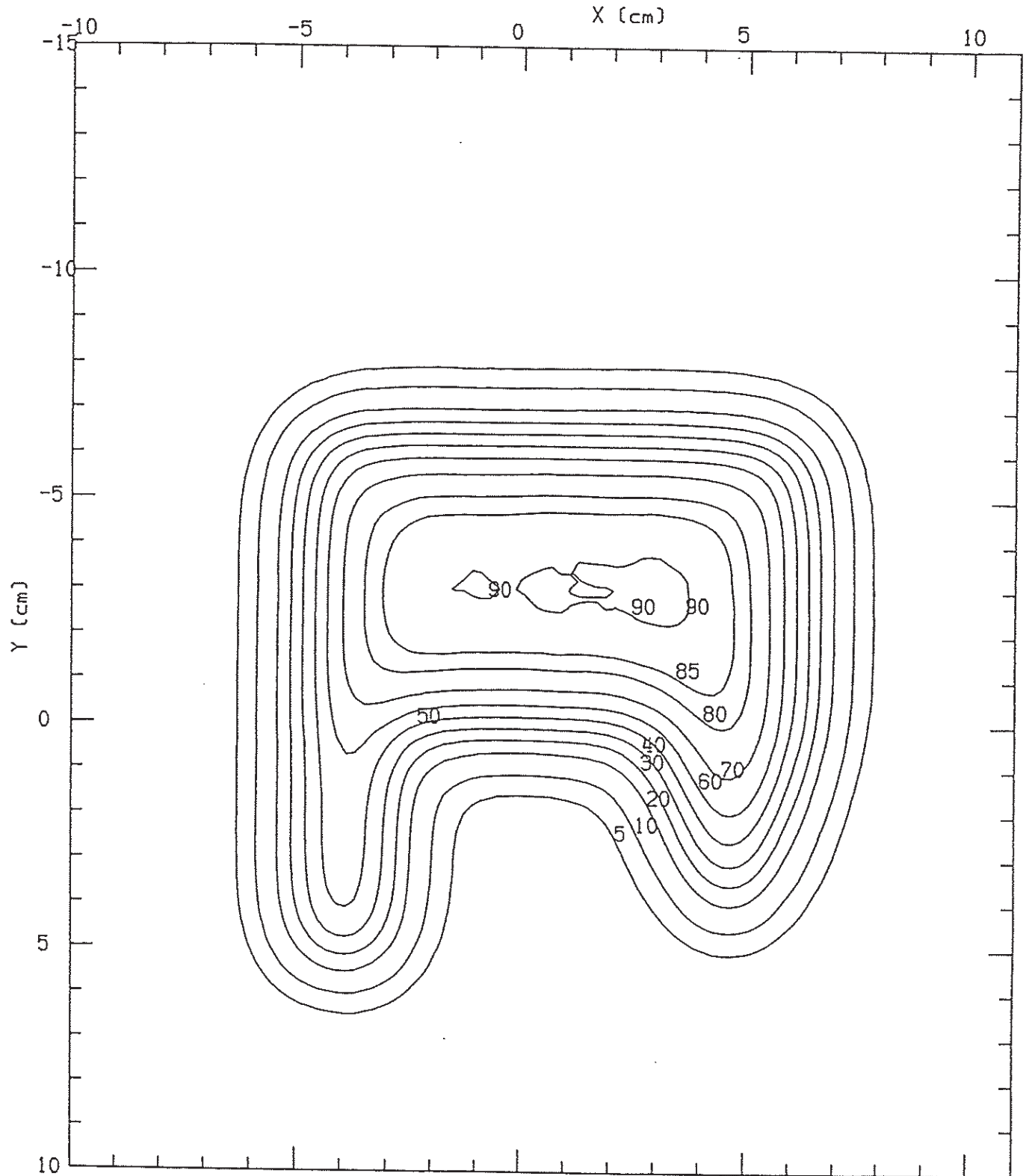

C11BEV09IRRZ036\_MOD

QL 1800

15.0, 15.0

100.0

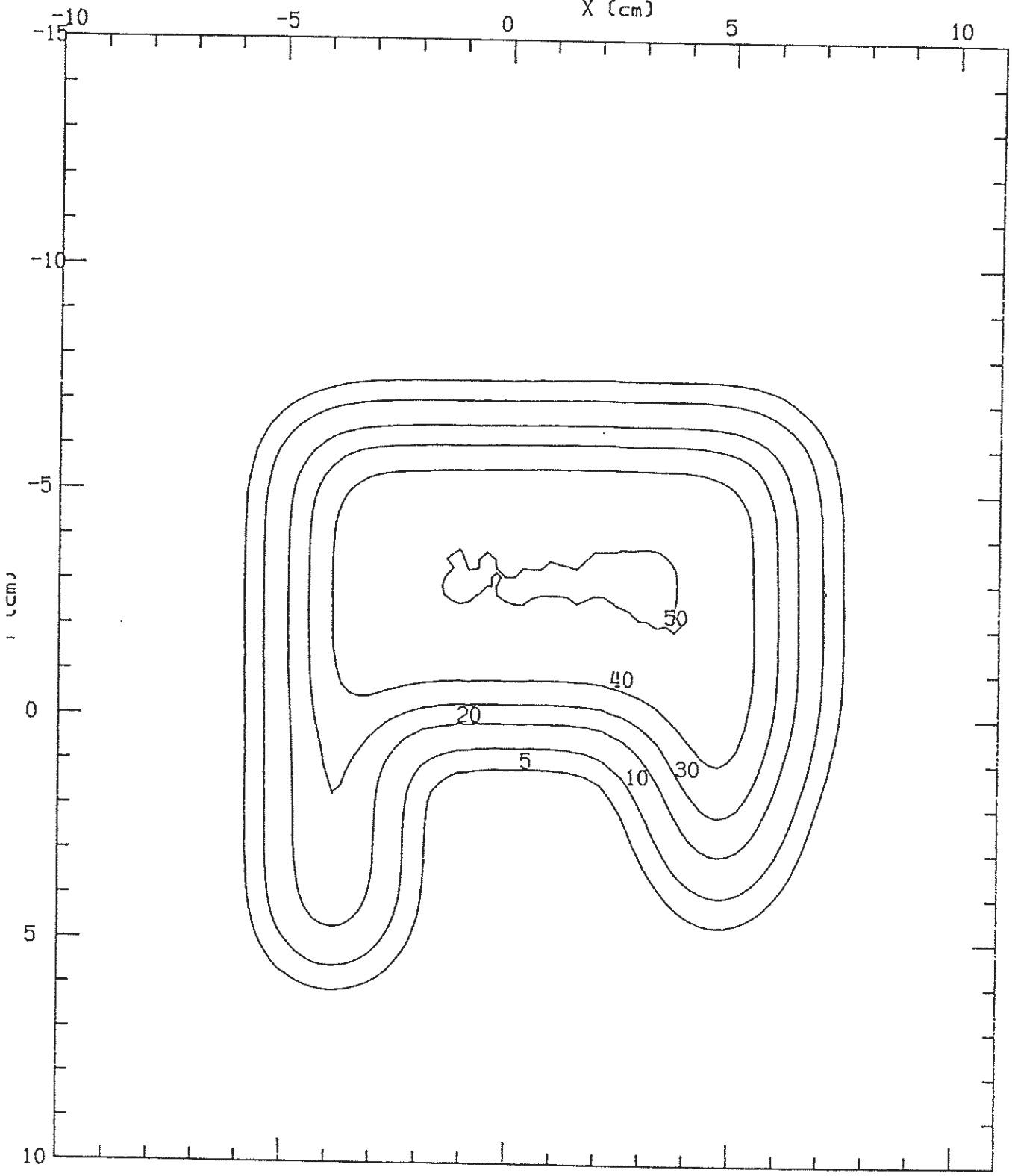

c12bev20\rrz061\_mod

QL 1800

100.0

15.0, 15.0

X (cm)

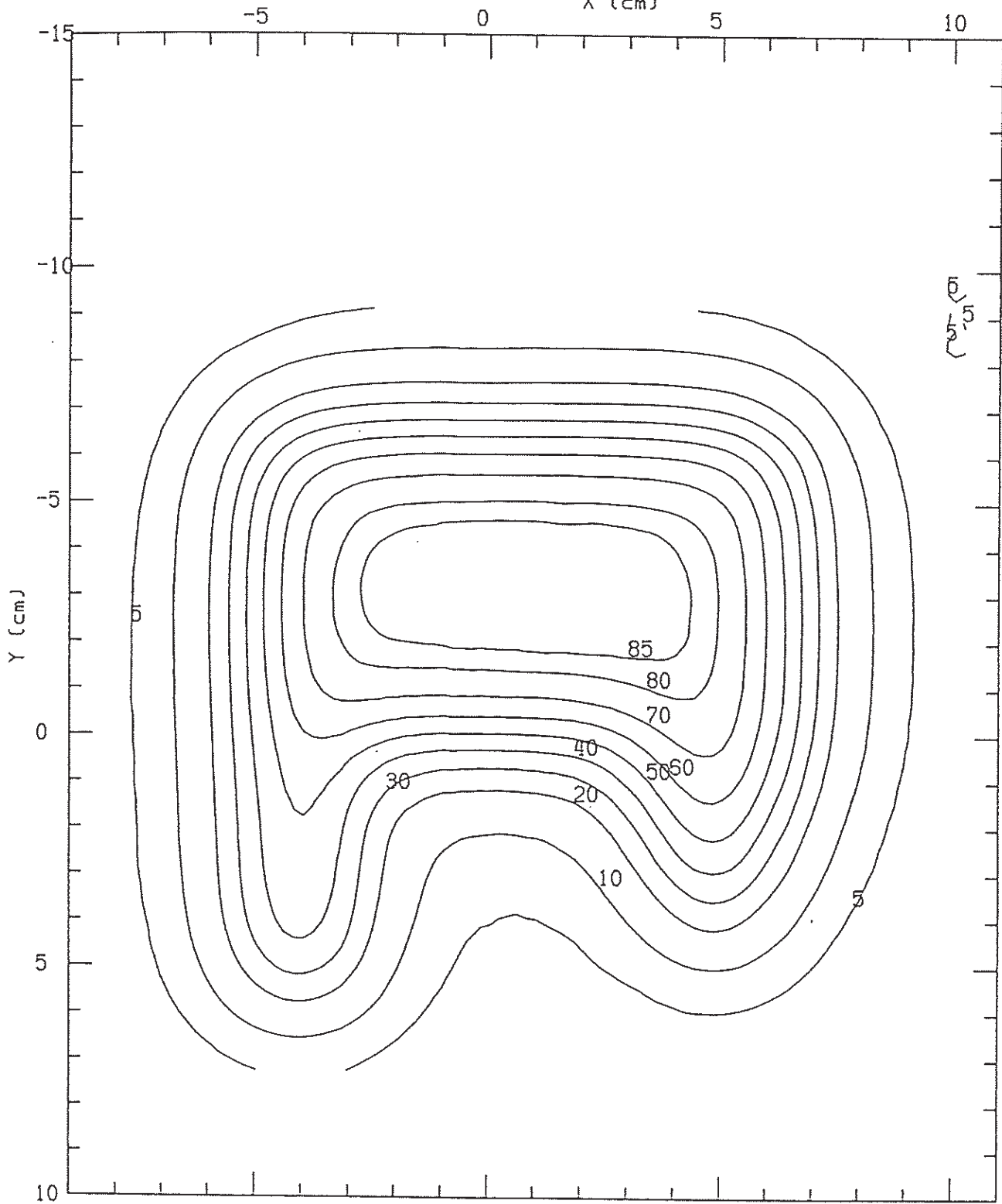

8863

C12BEV20IRRZ082\_MOD CL1800

100.0

15.0, 15.0

X (cm)

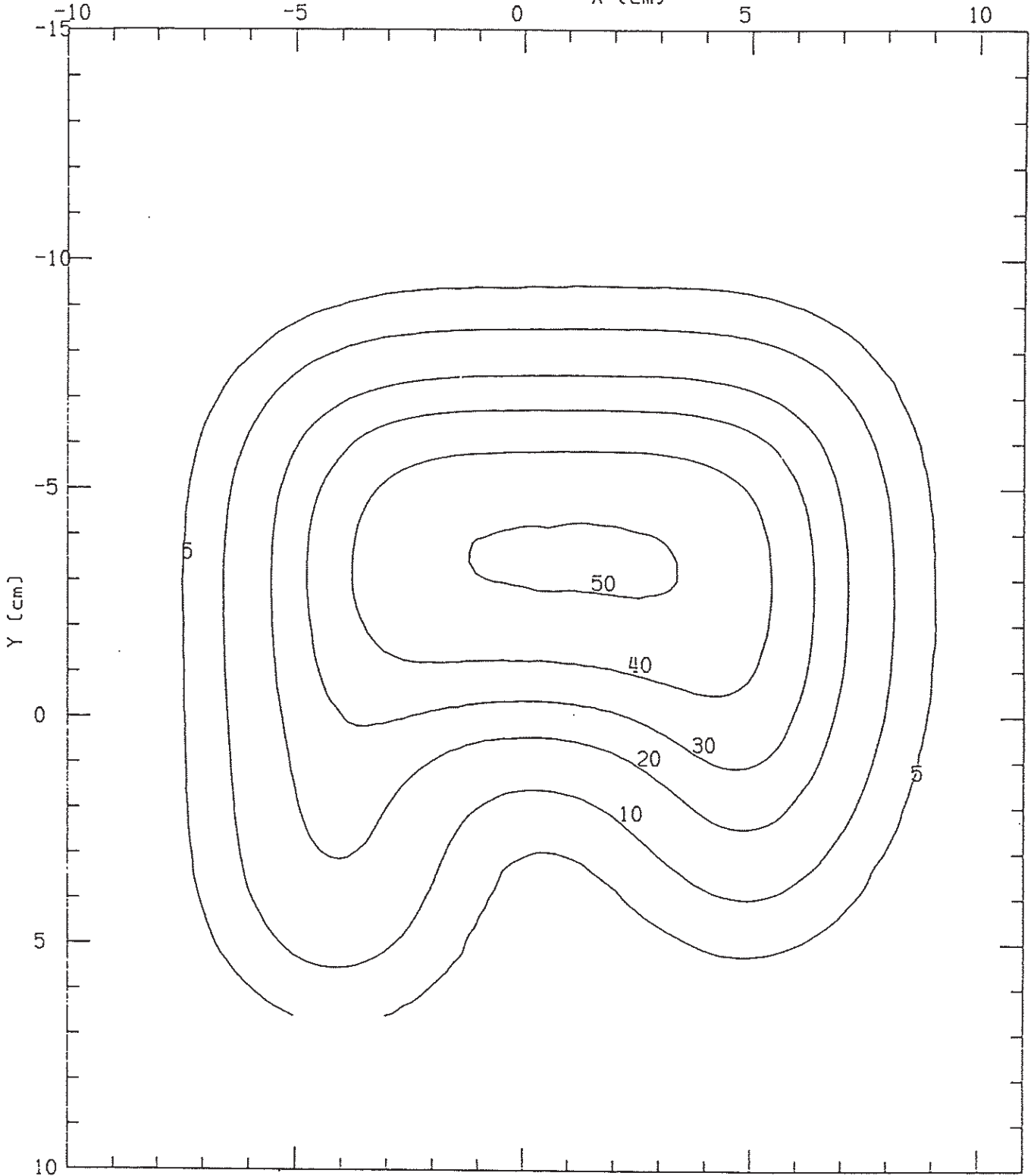

C14BEV09EYEZ026\_MOD

CL1800

97.0

6.0 6.0

X (cm)

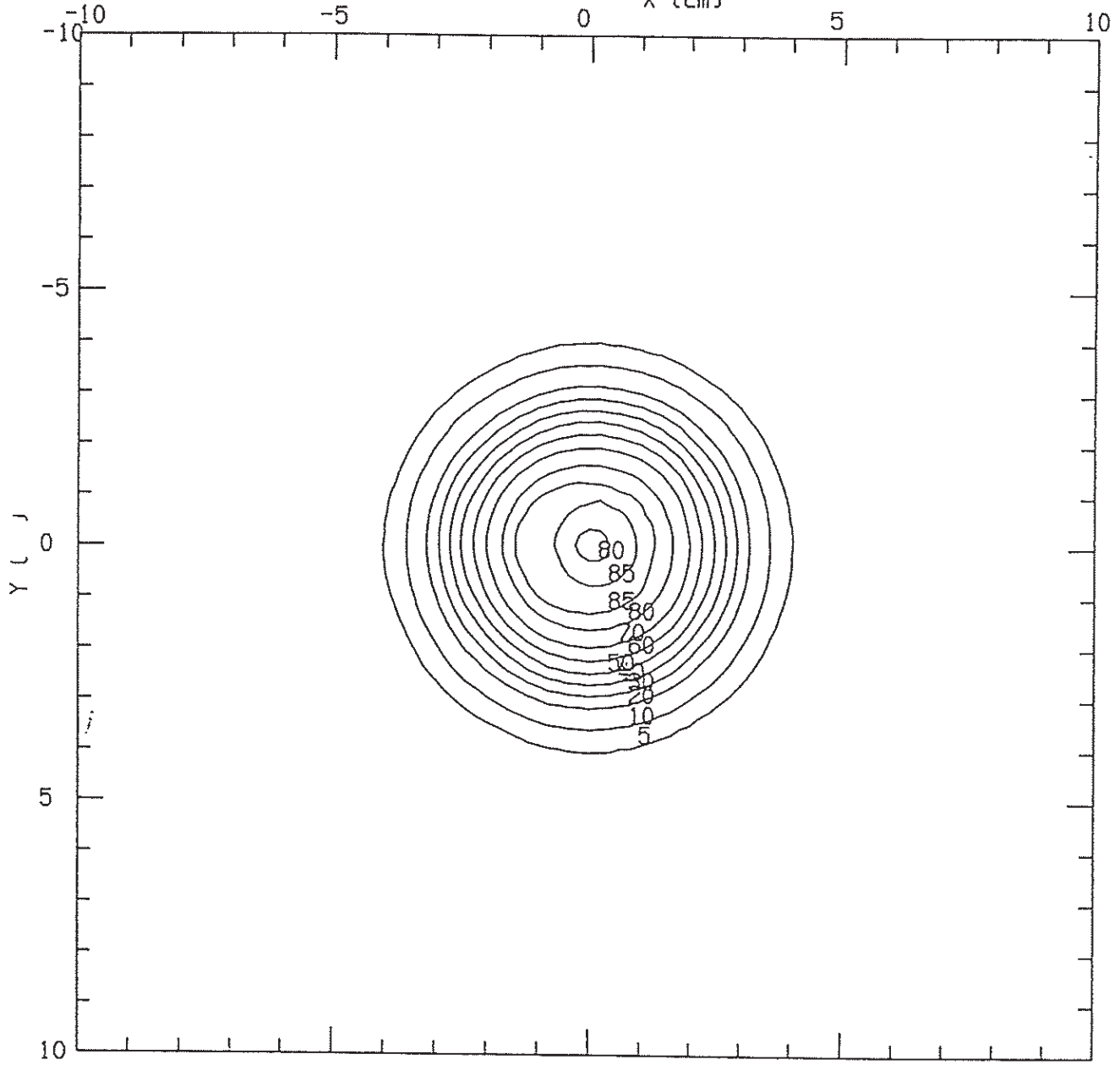

c15bev09150z002\_mod

CL1800

105.0

15.0, 15.0

X (cm)

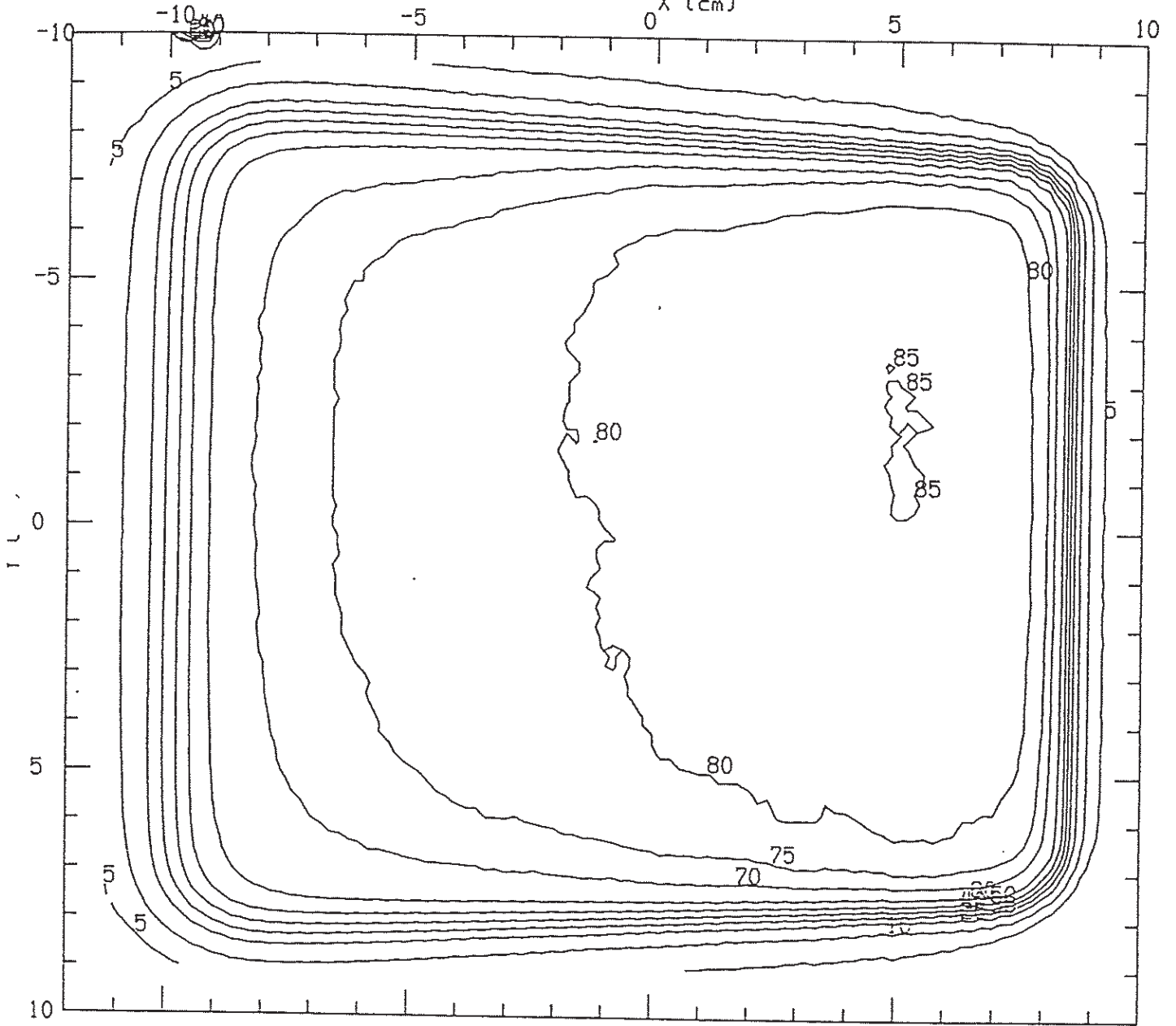

C16BEV20150Z002\_MOD

CL1800

15.0, 15.0

105.0

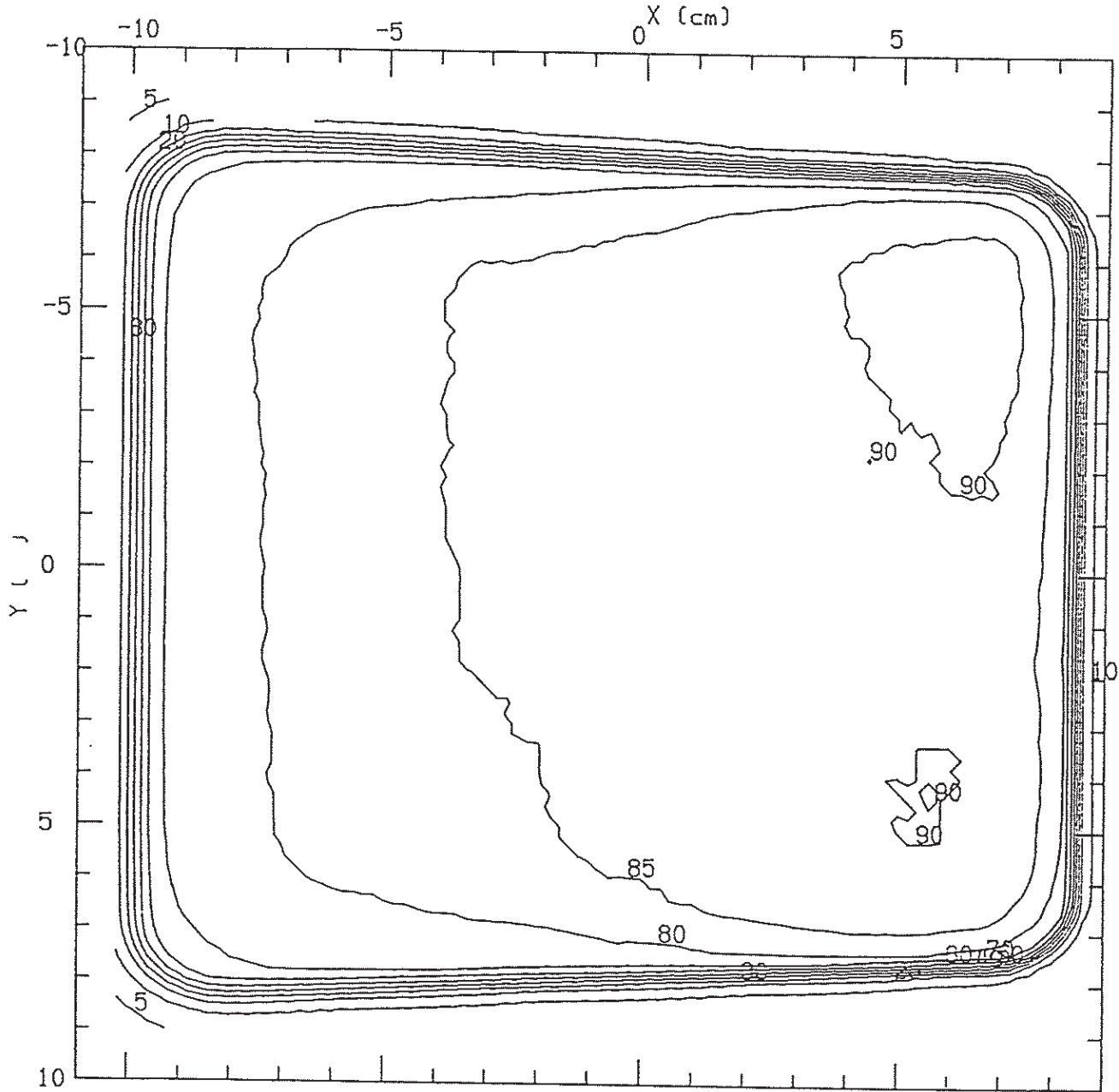

c19bev09150z002\_mod

CL1800

15.0, 15.0

100.0

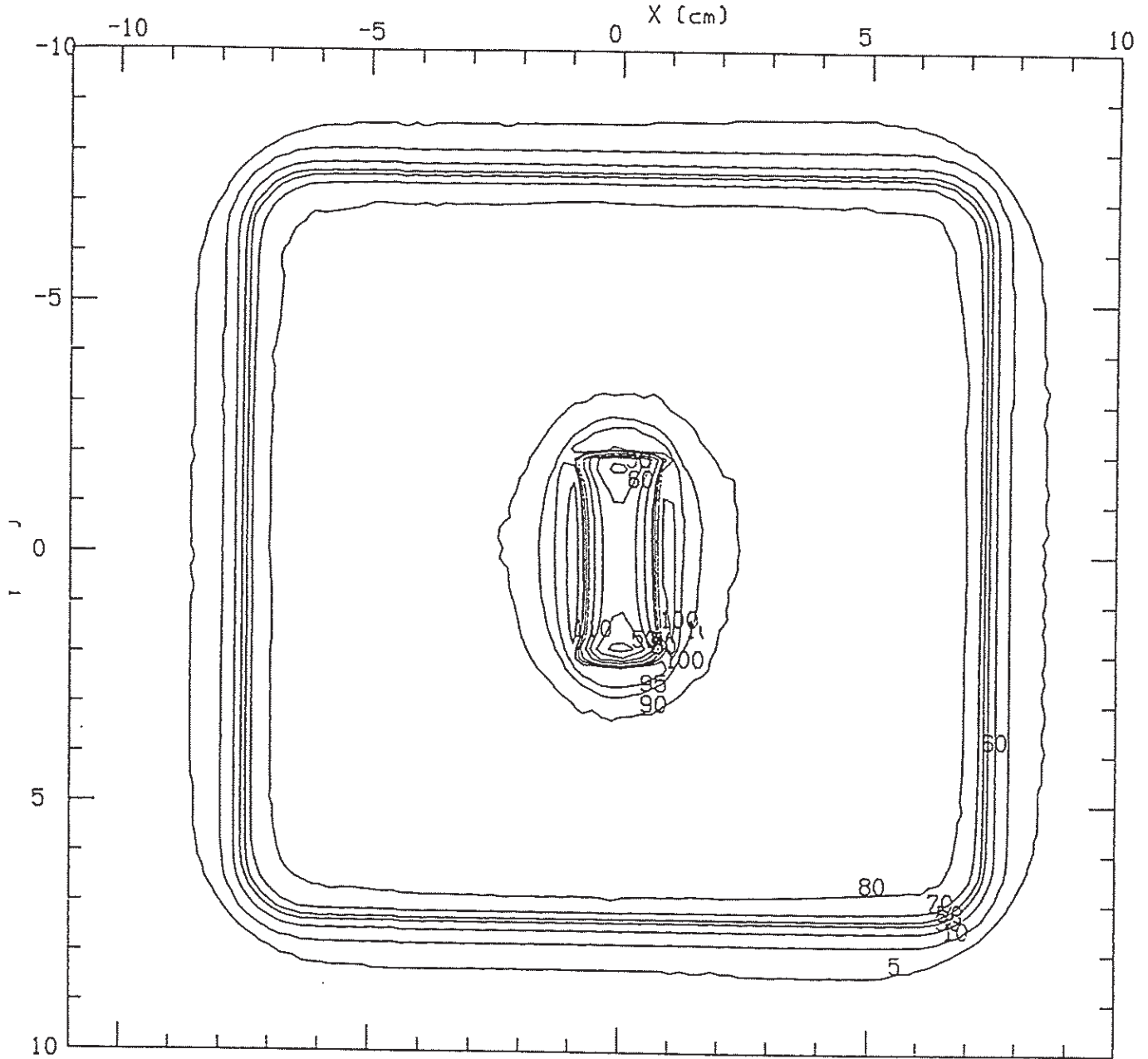

c19bev09150z028\_mod

CL1800

15.0, 15.0  
X (cm)

100.0

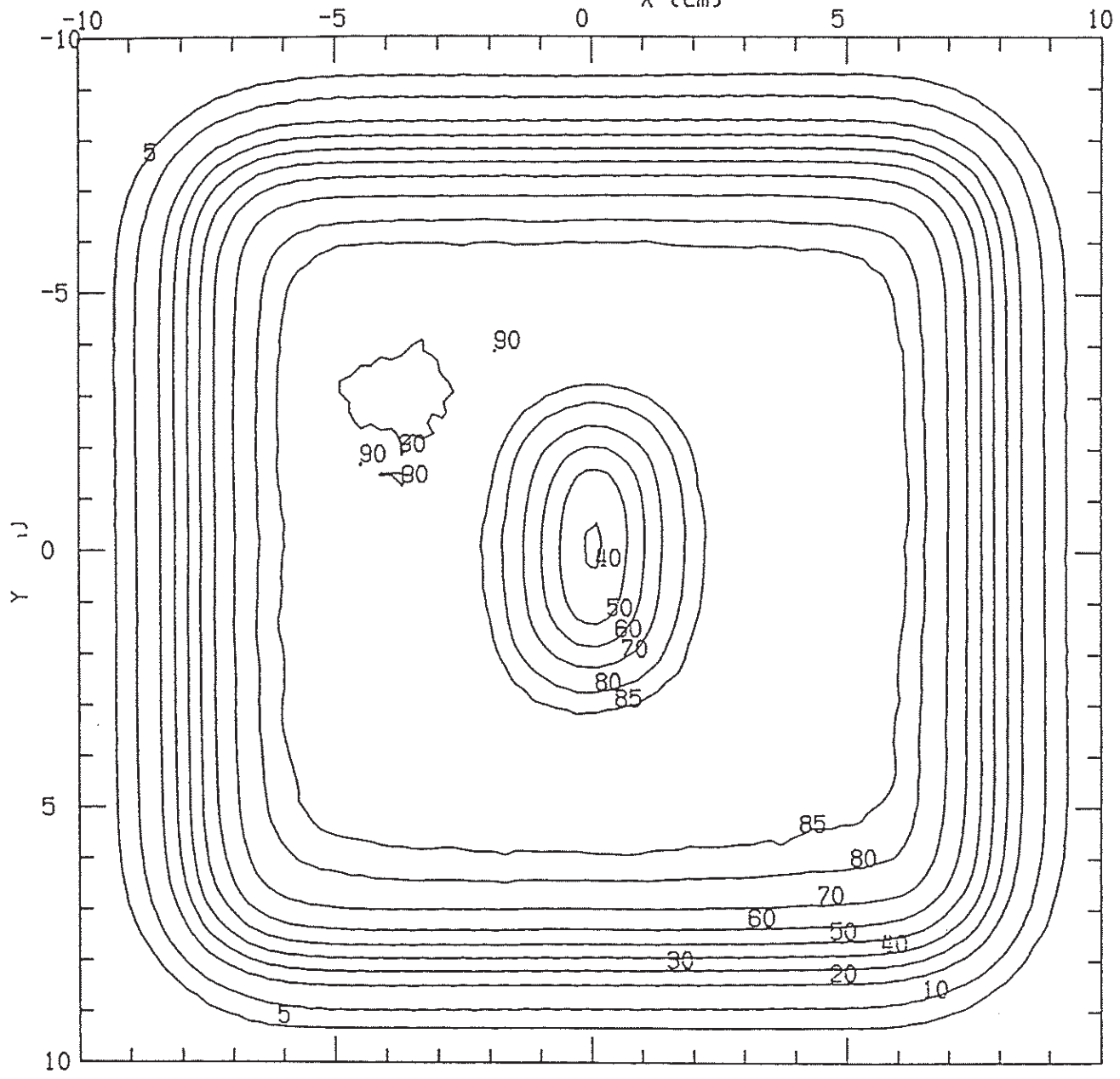

27 12 15 10 2  
-5 -4 -3 -2 -1

C20BEV20150Z031\_MOD

CL1800

15.0, 15.0

100.0

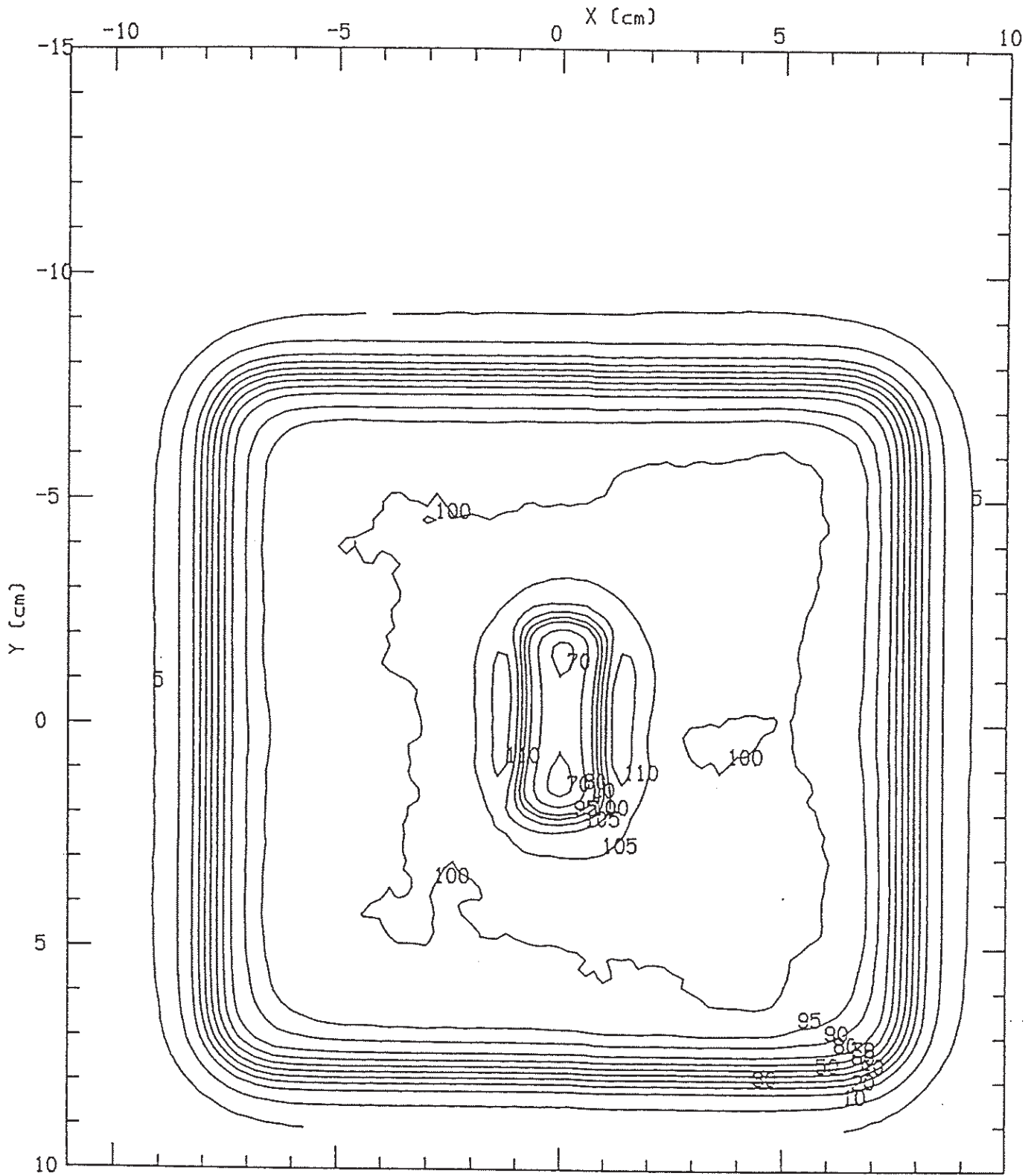

c20bev20150z061\_mod

CL1800

15.0, 15.0

100.0

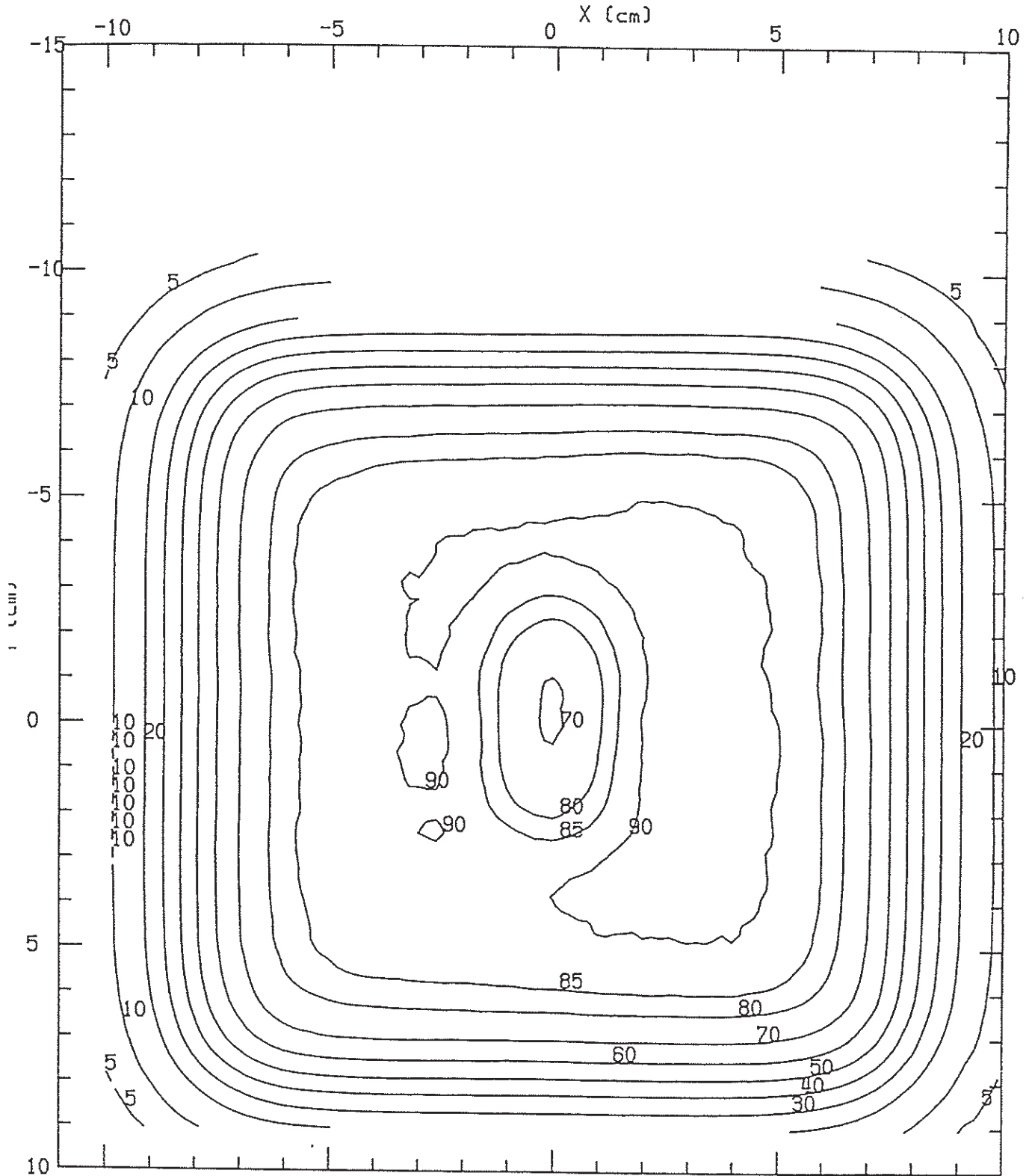

c21bev09150z060\_mod

CL1800

15.0, 15.0

100.0

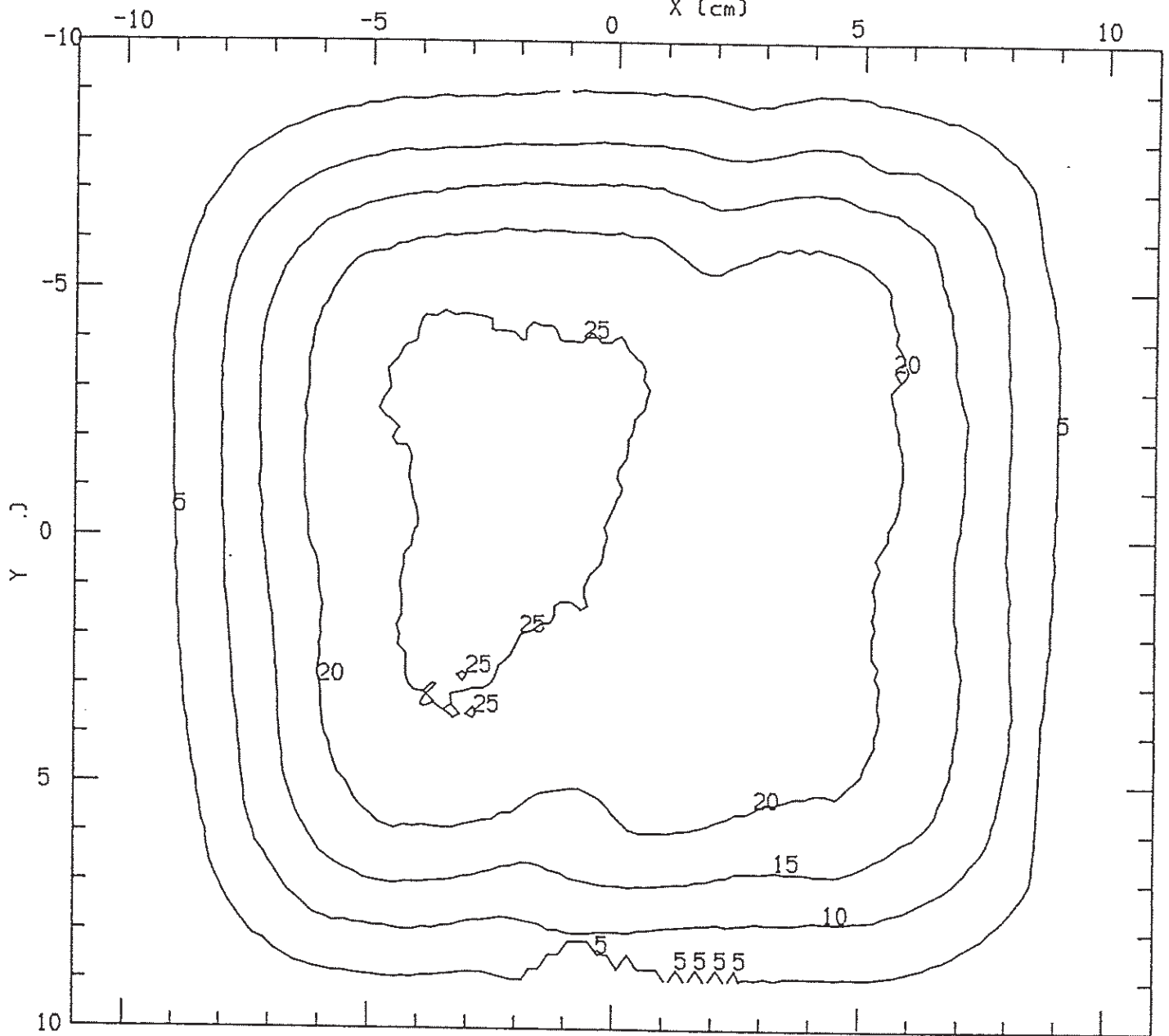

C22BEV20150Z050\_MOD

CL1800

100.0

15.0, 15.0

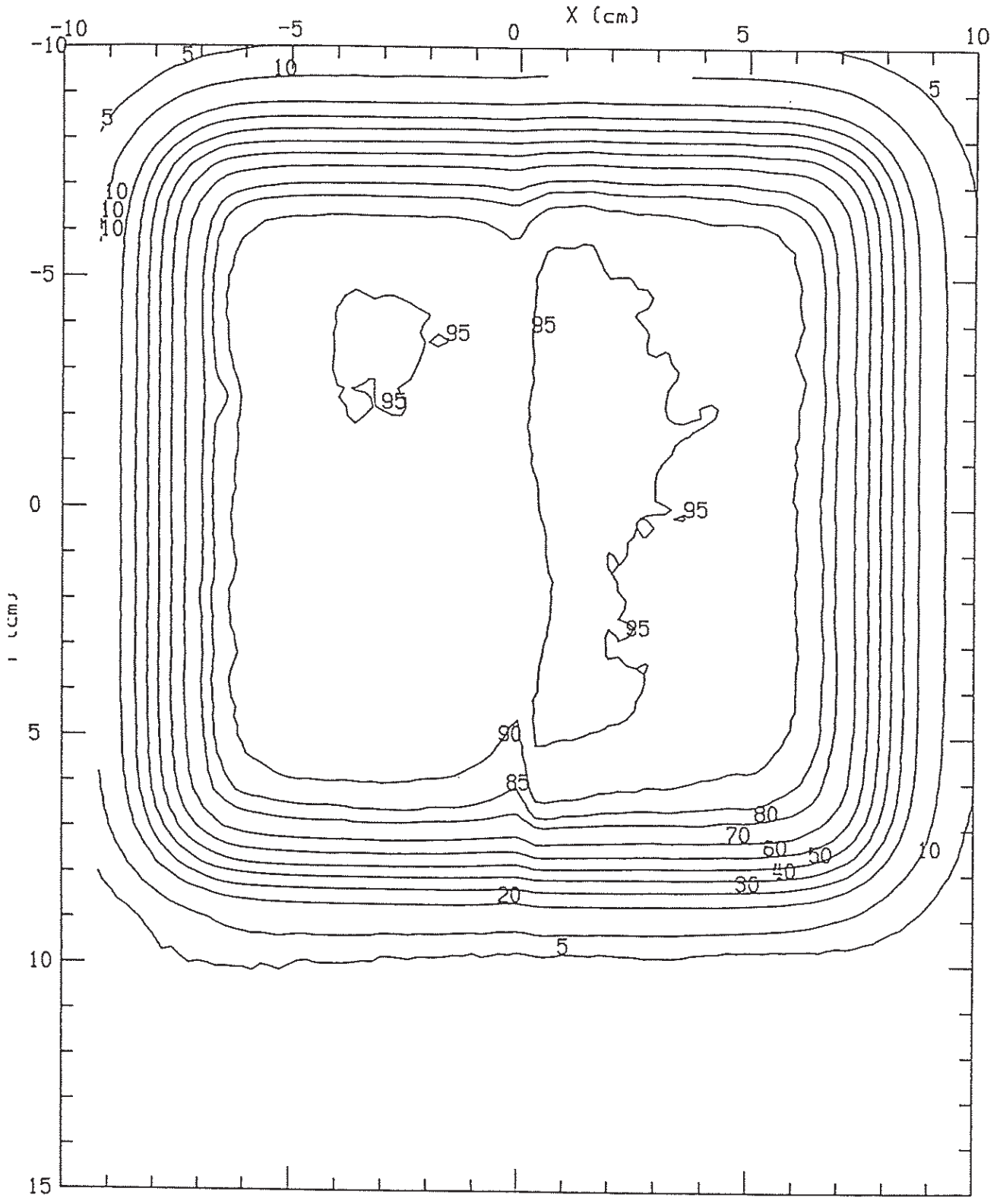

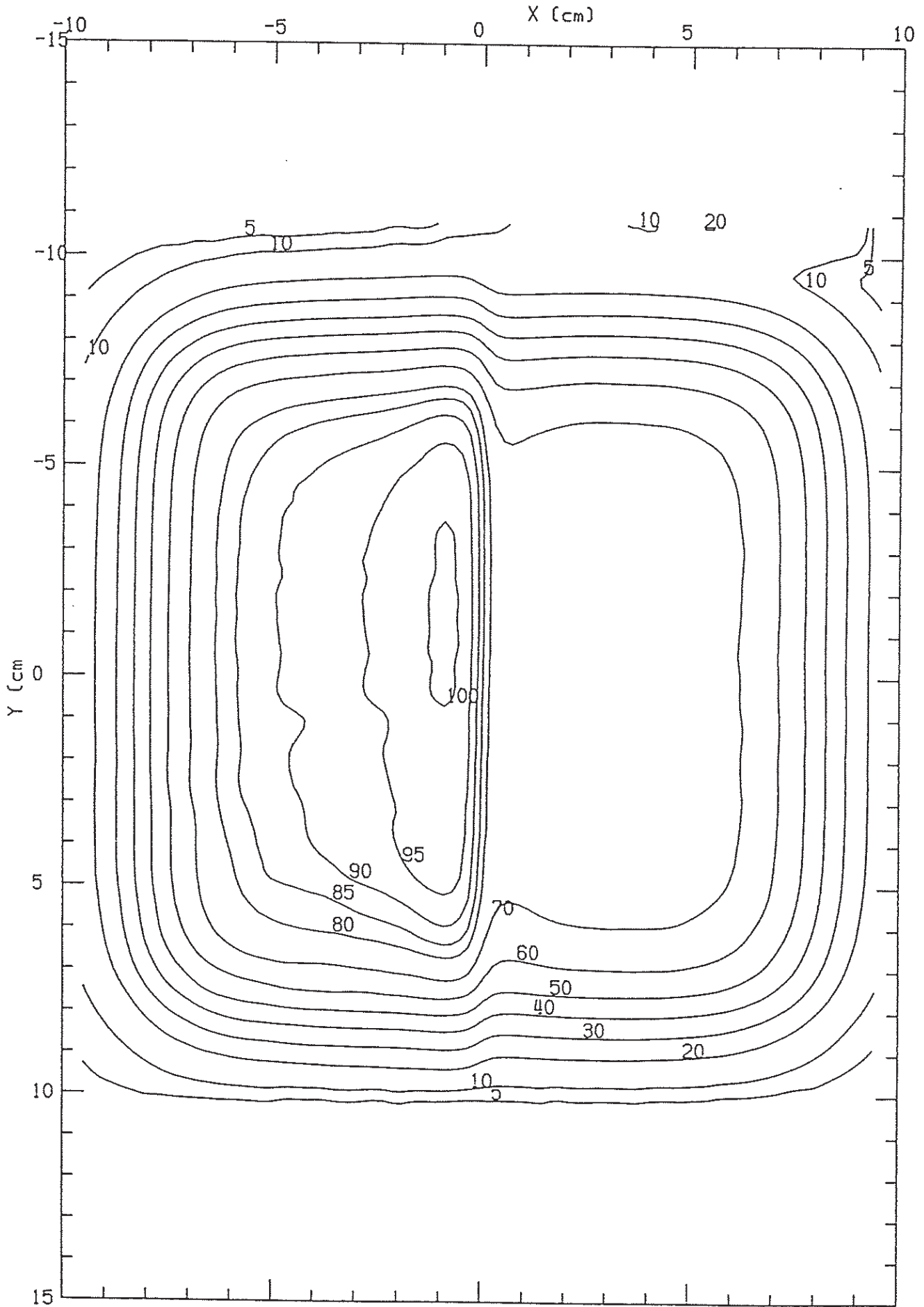

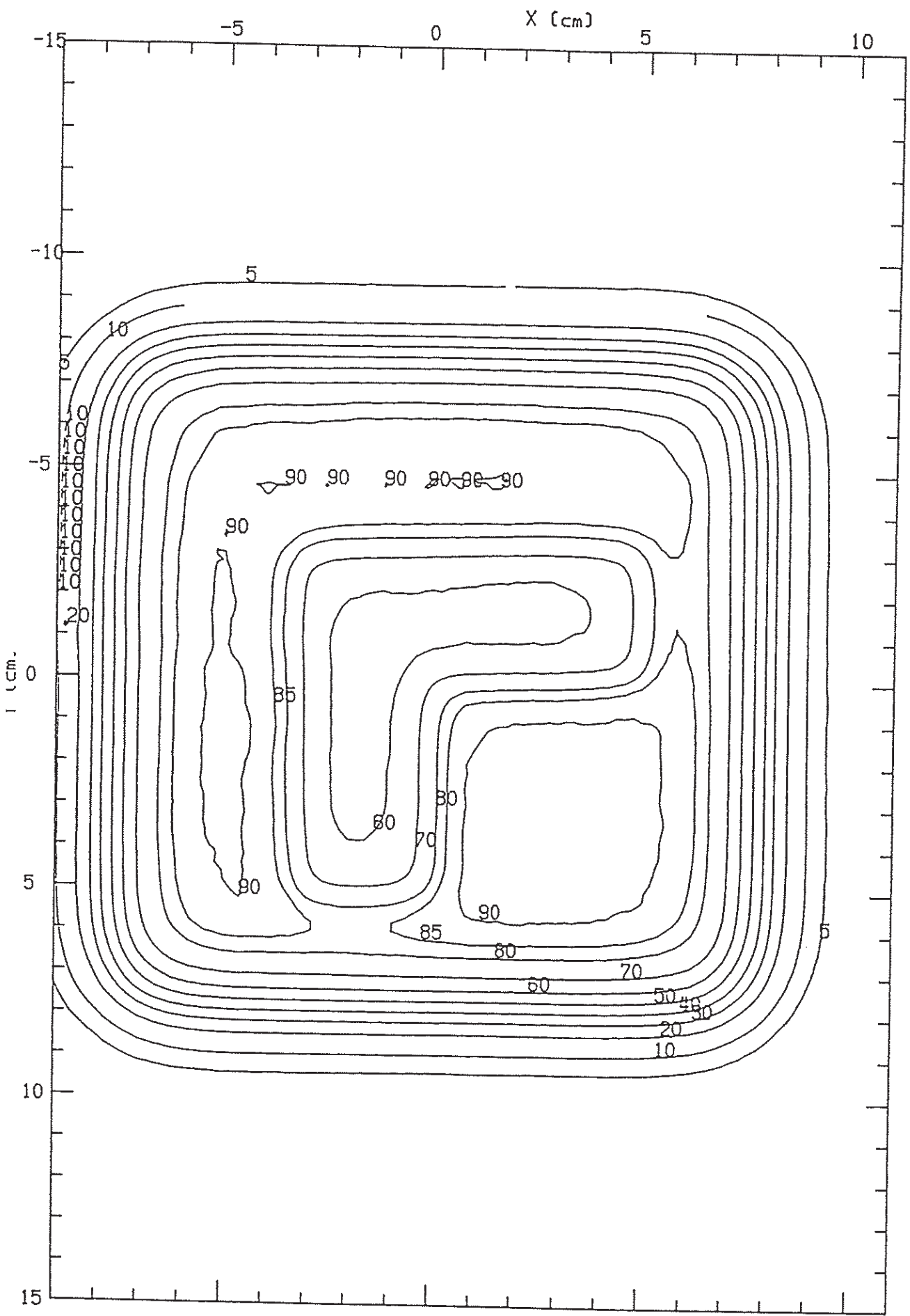

c28bev203d1z061\_mod

CL1800

15.0, 15.0

100.0

